

Precision and Analytical Balances

MS-TS

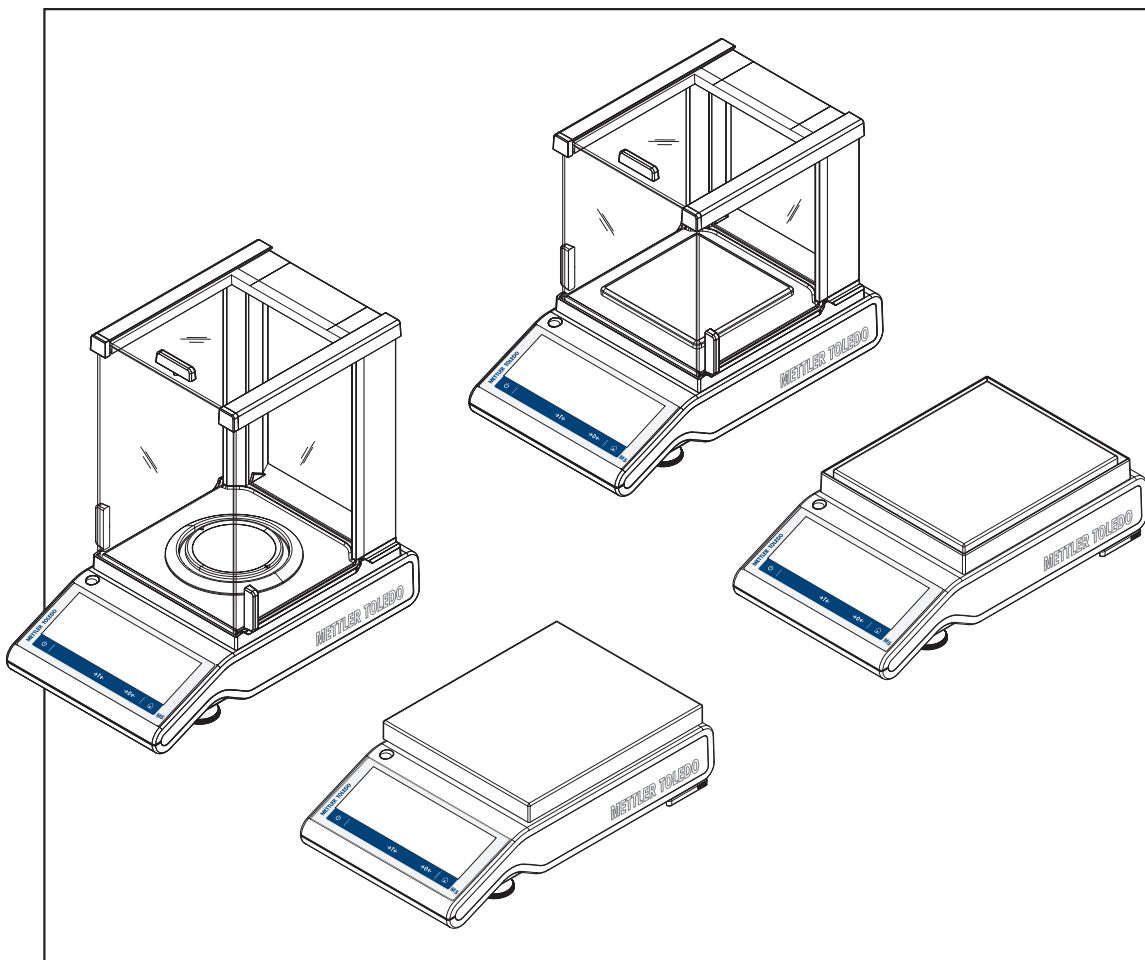

METTLER TOLEDO

Table of Contents

1	Introduction	5
1.1	Further documents and information	5
1.2	Explanation of conventions and symbols used	5
1.3	Acronyms and abbreviations	6
1.4	Compliance information	6
2	Safety Information	7
2.1	Definitions of signal warnings and warning symbols	7
2.2	Product specific safety notes	7
3	Design and Function	9
3.1	Overview balance	9
3.2	Overview peripheral devices	10
3.3	Overview type plate	11
3.4	Overview operation keys	11
3.5	User interface	12
3.5.1	Main settings and activities at a glance	12
3.5.2	Application home screen	13
3.5.3	Entering characters and numbers	14
3.5.4	Lists and tables	15
3.5.5	Basic navigation	15
3.5.5.1	Touch screen navigation	15
3.5.6	Detailed balance information	17
4	Installation and Putting into Operation	19
4.1	Selecting the location	19
4.2	Unpacking	19
4.3	Scope of delivery	20
4.4	Assembling the balance	20
4.5	Putting into operation	22
4.5.1	Connecting the balance	22
4.5.2	Switching on the balance	23
4.5.3	Changing the date and time	23
4.5.4	Leveling the balance	24
4.5.4.1	Leveling the balance using the level indicator	24
4.5.4.2	Leveling the balance using the leveling assistant	25
4.5.5	Adjusting the balance	26
4.6	Performing a simple weighing	27
4.7	Transporting, packaging and storage	29
4.7.1	Transporting over short distances	29
4.7.2	Transporting over long distances	29
4.7.3	Packaging and storage	29
4.8	Weighing below the balance	29
5	General Settings	31
5.1	Quick settings/Preferences	31
5.1.1	Brightness	31
5.1.2	Sound	32
5.1.3	Language	32
5.1.4	Glove mode	32
5.1.5	Quick adjustment	32
5.1.6	Date/Time widget	33
5.1.7	Leveling assistant	33
5.1.8	Change user password	34
5.2	General configuration and data	34

5.2.1	Weighing options.....	34
5.2.1.1	Weighing mode	34
5.2.1.2	Environment	34
5.2.1.3	Autozero	35
5.2.1.4	Auto tare	35
5.2.1.5	Auto clear tare	35
5.2.1.6	MinWeigh	36
5.2.1.7	Recall	36
5.2.2	Publishing.....	37
5.2.2.1	Print and export report	37
5.2.2.2	Send data	40
5.2.2.3	Advanced options.....	41
5.2.3	Devices and services.....	41
5.2.4	Network and Bluetooth.....	44
5.2.5	System settings.....	46
5.2.6	User management.....	47
5.2.6.1	General	48
5.2.6.2	Groups	48
5.2.6.3	Users.....	50
5.2.6.4	User login / lock / logout.....	52
5.2.7	ISO-Log	54
6	Application Settings	55
6.1	Main configuration	55
6.2	Reports configuration	55
6.2.1	Working with IDs	56
6.2.2	Defining an ID	57
6.2.3	Workflow handling options.....	57
6.3	Statistics.....	58
7	Activities	60
7.1	Activities - Weighing and other applications	60
7.1.1	Weighing	61
7.1.2	Counting	62
7.1.2.1	Counting - Main configuration.....	62
7.1.2.2	Defining reference piece weight in standard mode.....	63
7.1.2.3	Defining reference piece weight in advanced mode.....	64
7.1.3	Check weighing	66
7.1.3.1	Check weighing - Main configurations	66
7.1.3.2	Before performing check weighing operation.....	67
7.1.3.3	Performing check weighing	68
7.1.4	Dynamic weighing	69
7.1.5	Percent weighing	71
7.1.6	Formulation.....	72
7.1.7	Totaling	75
7.1.8	Back-weighing.....	78
7.1.9	Differential weighing	81
7.1.9.1	Working with the differential weighing application	83
7.1.10	Density	92
7.1.11	Factor weighing	94
7.2	Activities - Adjustments and tests	95
7.2.1	Activities reports configuration	95
7.2.2	Fully automatic adjustment (FACT).....	95
7.2.3	Internal adjustment.....	96
7.2.4	External adjustment.....	96
7.2.5	Fine adjustment (model-dependent)	97
7.2.6	Touch screen adjustment	97
7.2.7	Level indicator center adjustment	97

7.2.8	Routine test	98
7.2.9	Repeatability test	99
8	Communication with Peripheral Devices and Networks	100
8.1	USB - interface and installation	100
8.2	Send weight value via USB or RS232C to a PC using PC-Direct	101
8.2.1	PC-Direct via USB	101
8.2.2	PC-Direct via RS232C	102
8.2.2.1	Installing SerialPortToKeyboard software	102
8.2.2.2	Settings on the balance	103
8.3	Collecting measurement results and balance details with EasyDirect Balance	104
8.4	Connect via USB to a printer and print weighing results	106
8.5	Connect via LAN to a P-50 printer and print weighing results	107
8.6	Connect via Bluetooth to a P-50 printer and print weighing results	108
8.7	Connect to web access via LAN	109
8.8	Connect a USB barcode reader and scan the barcode	110
8.9	Connect a USB keyboard	111
8.10	Export measurement results to a USB memory stick	112
8.11	Export XML files to a FTP server and import them with the help of a XSD file	113
8.12	Communication with MT-SICS commands via LAN	115
9	Maintenance	116
9.1	Maintenance tasks	116
9.2	Cleaning	116
9.2.1	Cleaning the glass draft shield (0.1 mg and 1 mg models)	116
9.2.2	Cleaning the balance	119
9.2.3	Putting into operation after cleaning	119
10	Troubleshooting	121
10.1	Error messages	121
10.2	Error symptoms	123
10.3	Status messages/Status icons	124
10.4	Putting into operation after fixing an error	126
11	Technical Data	127
11.1	General data	127
11.2	Model-specific data	129
11.2.1	Analytical balances with a readability of 0.1 mg with draft shield	129
11.2.2	Precision balances with a readability of 1 mg with draft shield	130
11.2.3	Precision balances with a readability of 10 mg	132
11.2.4	Precision balances with a readability of 100 mg	135
11.3	Dimensions	136
11.3.1	Balances with a readability of 0.1 mg with draft shield	136
11.3.2	Balances with a readability of 1 mg with draft shield	137
11.3.3	Balances with a readability of 10 mg	138
11.3.4	Balances with a readability of 100 mg	139
11.4	Interface specifications	140
11.4.1	RS232C interface	140
11.4.2	USB host	141
11.4.3	USB device	141
11.4.4	Ethernet	141
11.4.5	Wi-Fi and Bluetooth	142
11.4.6	MT-SICS interface commands and functions	142
12	Accessories and Spare Parts	143
12.1	Accessories	143
12.2	Spare parts	149
12.2.1	Balances with a readability of 0.1 mg with draft shield (236 mm)	149

12.2.2	Balances with a readability of 1 mg with draft shield (168 mm)	150
12.2.3	Balances with a readability of 10 mg	151
12.2.4	Balances with a readability of 100 mg	152
13	Disposal	153
14	Appendix	154
14.1	Compliance information.....	154
	Index	155

1 Introduction

Thank you for choosing a METTLER TOLEDO balance. The balance combines high performance with ease of use.

This document is based on the software version V 4.20.

EULA

The software in this product is licensed under the METTLER TOLEDO End User License Agreement (EULA) for Software.

▶ www.mt.com/EULA

When using this product you agree to the terms of the EULA.

1.1 Further documents and information

▶ www.mt.com/MS-TS-analytical-balance

▶ www.mt.com/MS-precision

This document is available in other languages online.

▶ www.mt.com/ms-ts-RM

Search for software downloads

▶ www.mt.com/labweighing-software-download

Search for documents

▶ www.mt.com/library

For further questions, please contact your authorized METTLER TOLEDO dealer or service representative.

▶ www.mt.com/contact

1.2 Explanation of conventions and symbols used

Conventions and symbols

Key and/or button designations and display texts are shown in graphic or bold text, e.g.,  **Language**.

 **Note** For useful information about the product.



Refers to an external document.

Elements of instructions

In this manual, step-by-step instructions are presented as follows. The action steps are numbered and can contain prerequisites, intermediate results and results, as shown in the example. Sequences with less than two steps are not numbered.

■ Prerequisites that must be fulfilled before the individual steps can be executed.

1 Step 1

➔ Intermediate result

2 Step 2

➔ Result

1.3 Acronyms and abbreviations

Original term	Explanation
ASTM	American Society for Testing and Materials
EMC	Electromagnetic Compatibility
FACT	Fully automatic time- and temperature-controlled internal adjustment
FCC	Federal Communications Commission
GWP	Good Weighing Practice
ID	Identification
LPS	Limited Power Source
MT-SICS	METTLER TOLEDO Standard Interface Command Set
OIML	Organisation Internationale de Métrologie Légale (International Organization of Legal Metrology)
RM	Reference Manual
SNR	Serial Number
SOP	Standard Operating Procedure
UM	User Manual
USB	Universal Serial Bus
USP	United States Pharmacopeia
AC	Alternating Current
DC	Direct Current
HID	Human Interaction Device
LAN	Local Area Network
MAC	Media Access Control

1.4 Compliance information

The compliance information related to this product can be found in appendix.

2 Safety Information

Two documents named "User Manual" and "Reference Manual" are available for this instrument.

- The User Manual is printed and delivered with the instrument.
- The electronic Reference Manual contains a full description of the instrument and its use.
- Keep both documents for future reference.
- Include both documents if you transfer the instrument to other parties.

Only use the instrument according to the User Manual and the Reference Manual. If you do not use the instrument according to these documents or if the instrument is modified, the safety of the instrument may be impaired and Mettler-Toledo GmbH assumes no liability.

2.1 Definitions of signal warnings and warning symbols

Safety notes contain important information on safety issues. Ignoring the safety notes may lead to personal injury, damage to the instrument, malfunctions and false results. Safety notes are marked with the following signal words and warning symbols:

Signal words

DANGER	A hazardous situation with high risk, resulting in death or severe injury if not avoided.
WARNING	A hazardous situation with medium risk, possibly resulting in death or severe injury if not avoided.
CAUTION	A hazardous situation with low risk, resulting in minor or moderate injury if not avoided.
NOTICE	A hazardous situation with low risk, resulting in damage to the instrument, other material damage, malfunctions and erroneous results, or loss of data.

Warning symbols



General hazard: read the User Manual or the Reference Manual for information about the hazards and the resulting measures.



Electrical shock



Notice

2.2 Product specific safety notes

Intended use

This instrument is designed to be used by trained staff. The instrument is intended for weighing purposes.

Any other type of use and operation beyond the limits of use stated by Mettler-Toledo GmbH without consent from Mettler-Toledo GmbH is considered as not intended.

Responsibilities of the instrument owner

The instrument owner is the person holding the legal title to the instrument and who uses the instrument or authorizes any person to use it, or the person who is deemed by law to be the operator of the instrument. The instrument owner is responsible for the safety of all users of the instrument and third parties.

Mettler-Toledo GmbH assumes that the instrument owner trains users to safely use the instrument in their workplace and deal with potential hazards. Mettler-Toledo GmbH assumes that the instrument owner provides the necessary protective gear.

Safety notes



WARNING

Death or serious injury due to electric shock

Contact with parts that carry a live current can lead to death or injury.

- 1 Only use the METTLER TOLEDO power cable and AC/DC adapter designed for your instrument.
- 2 Connect the power cable to a grounded power outlet.
- 3 Keep all electrical cables and connections away from liquids and moisture.
- 4 Check the cables and the power plug for damage and replace them if damaged.



NOTICE

Damage to the instrument or malfunction due to the use of unsuitable parts

- Only use parts from METTLER TOLEDO that are intended to be used with your instrument.

3 Design and Function

3.1 Overview balance

0.1 mg

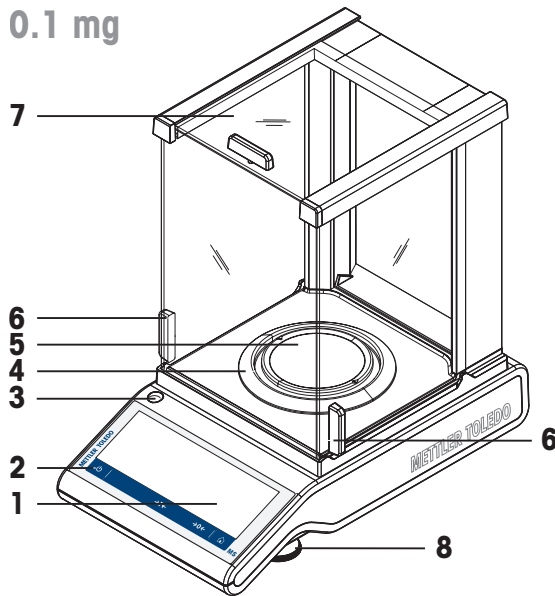

1 mg

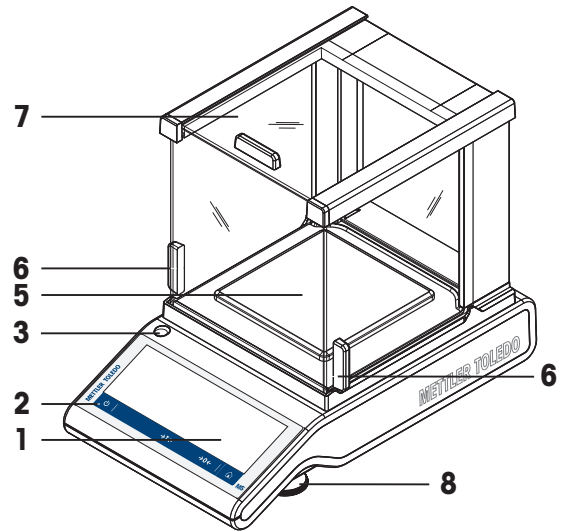

10 mg

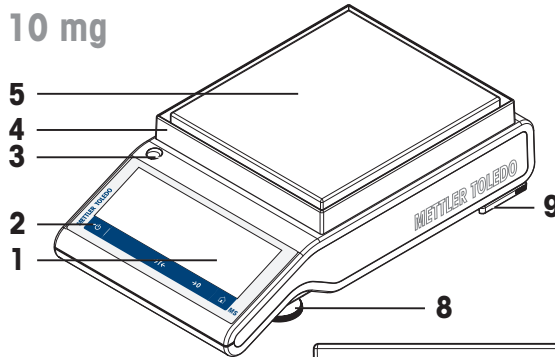

100 mg

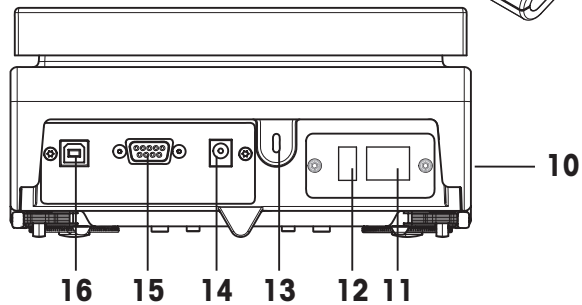
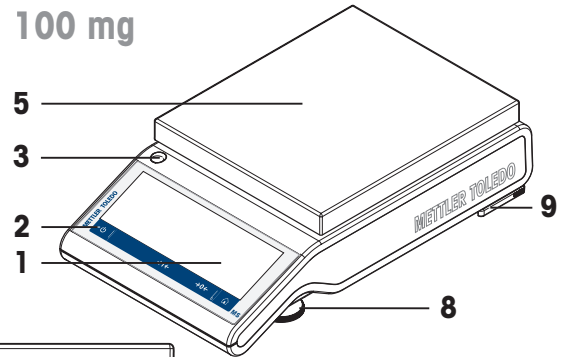

1	Capacitive color TFT touch screen	2	Operating keys
3	Level indicator	4	Draft shield element
5	Weighing pan	6	Handle for operation of the draft shield door
7	Glass draft shield	8	Leveling foot
9	Safety feet (10 mg and 100 mg models)	10	Product label
11	Ethernet port	12	USB host port
13	Kensington slot for anti-theft purposes	14	Socket for AC/DC adapter
15	RS232C serial interface	16	USB device port

3.2 Overview peripheral devices

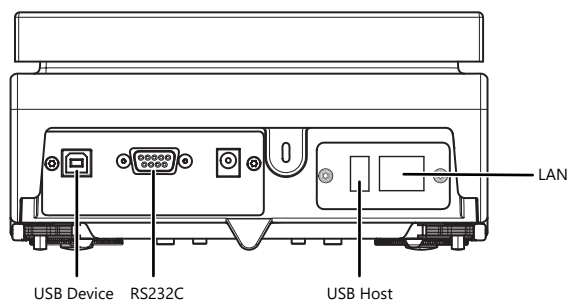

Interfaces and possible connectivity of peripheral devices:

USB DEVICE	RS232C	USB HOST	LAN
PC	RS-P20 / P-50 printer	Barcode reader	LAN
	Barcode reader	USB-P25 printer	P-50 printer
	RS 2 nd display	P-50 printer	
	PC	USB memory stick	
USB Keyboard			
		Wireless dongle MTICWD-100	

For more information about peripheral devices, see [Accessories ▶ Page 143].

3.3 Overview type plate

The balance type plate is located at the side of the balance and contains the following information (example illustration):

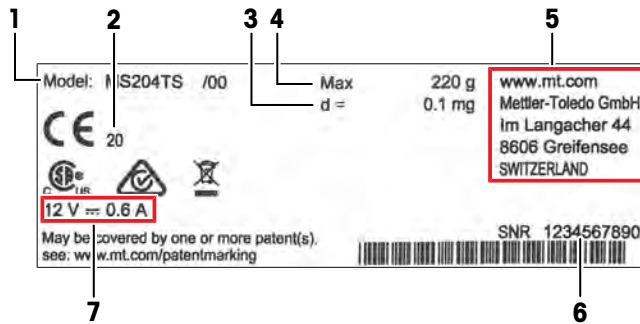

1	Model designation	2	Year of manufacture
3	Readability	4	Maximum capacity
5	Manufacturer	6	Serial number (SNR)
7	Power supply		

3.4 Overview operation keys

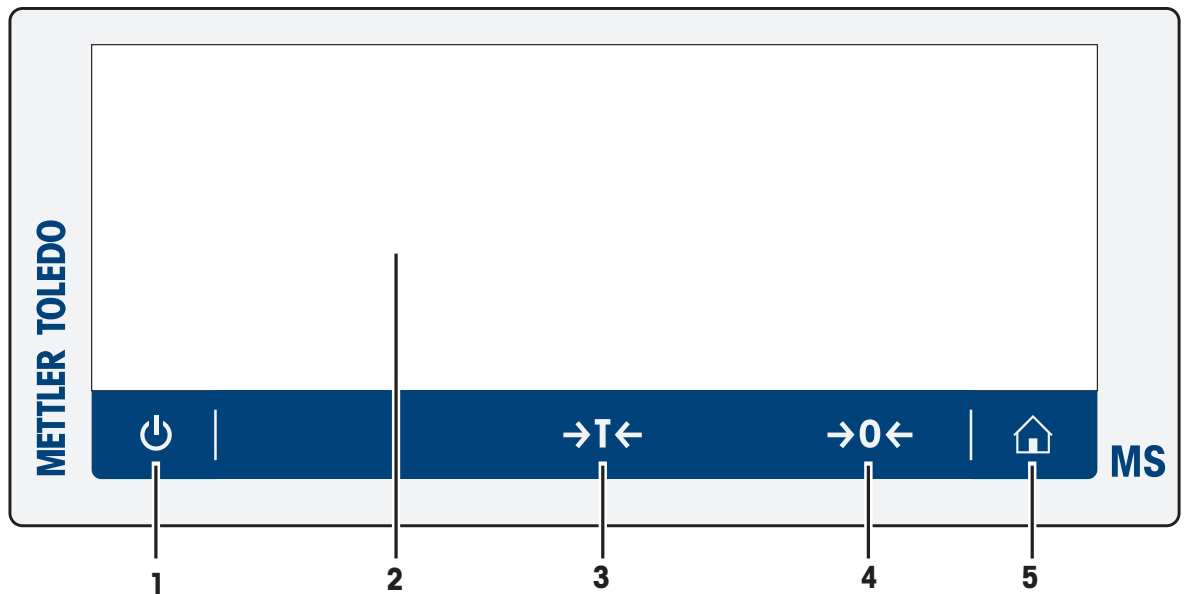

	Key	Name	Description
1		ON/OFF	Switches the balance on or off.
2		Capacitive color TFT touch screen	General navigation
3		Tare	Tares the balance.
4		Zero	Zeros the balance.
5		Home	Returns from any menu level, or other window to the application home screen.

3.5 User interface

The screen displays information and allows the user to enter commands by tapping certain areas on its surface. You can choose the information displayed on the screen, change the balance settings and perform certain operations on the balance.

3.5.1 Main settings and activities at a glance

Depending on the application, the options available to be selected and their content may differ.

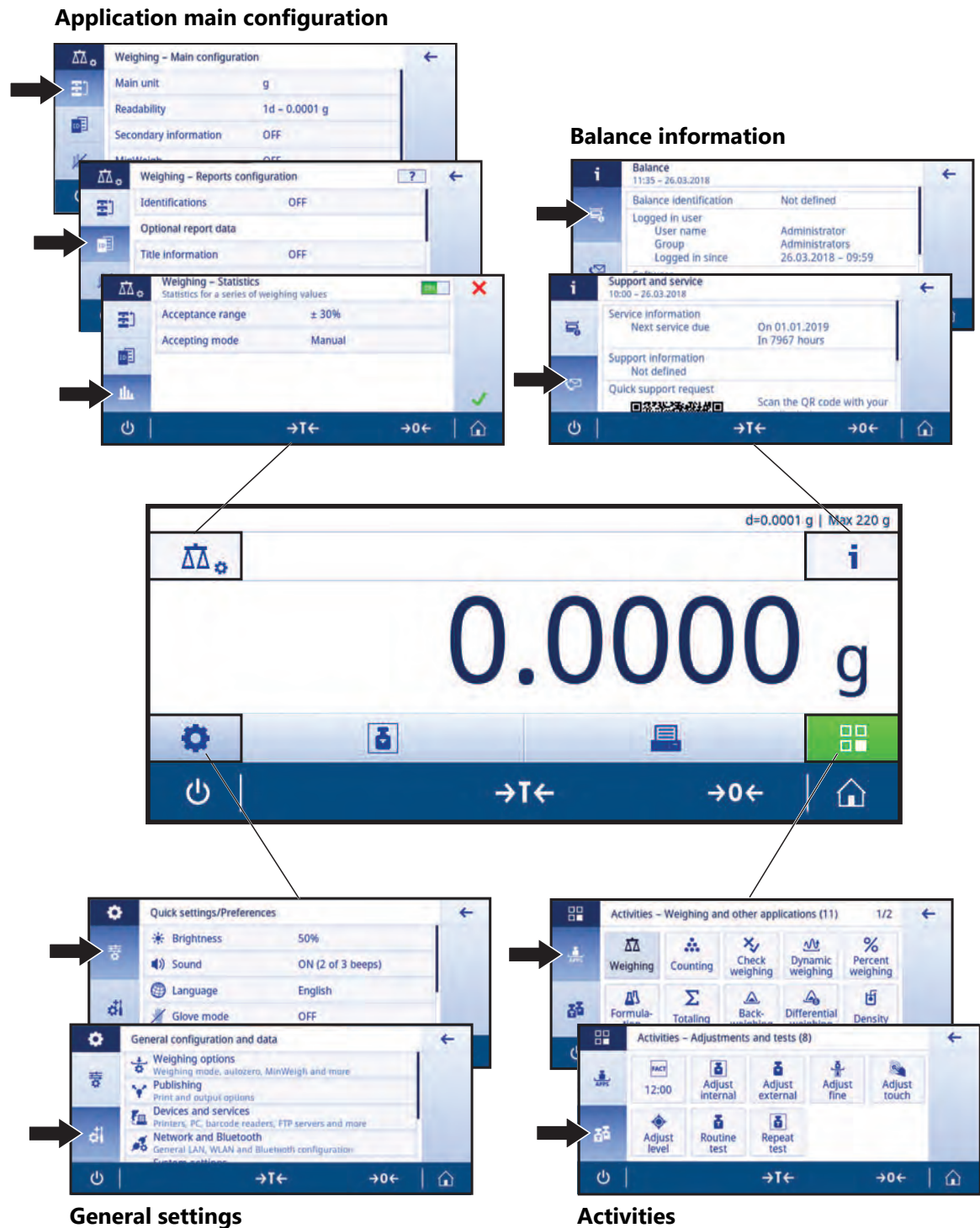

3.5.2 Application home screen

The application home screen appears after switching the balance on. It always displays the last application that was in use before the balance was switched off. The application home screen is the main screen of the balance. Every function can be accessed from here. You can return to the application home screen at any time by pressing the home button  in the lower right corner of the screen.

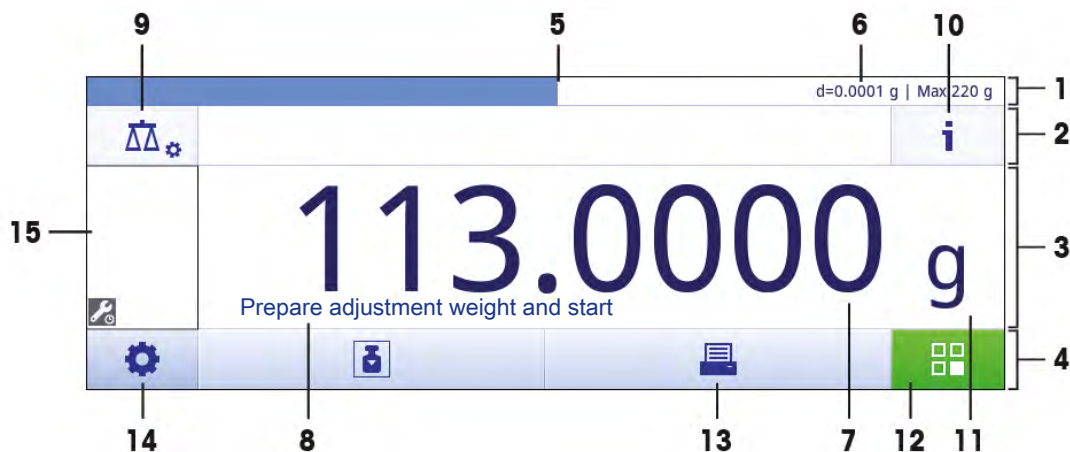

Information and work bars

	Name	Description
1	Weighing information bar	Displays the weighing-in aid and general balance information.
2	Work title bar	Displays information about the current activity.
3	Value bar	Displays information about the current weighing process.
4	Main navigation	Work-related functions.

Information fields

	Name	Description
5	Weighing-in aid	A dynamic graphic indicator displays how much of the total weighing range is in use.
6	Short balance information	Readability and capacity of the balance.*
7	Weighing value field	Displays the value of the current weighing process (model-specific).
8	Coach text field	Displays instructions for the current weighing process.

* For legal-for-trade approved balances: **Min** (minimum capacity) and **e** (verification of scale interval) are shown in the upper left corner.

Action buttons

	Name	Description
9	Main activity configuration	To configure the current application, e.g., Weighing .
10	Detailed balance information	Displays detailed technical data about the balance.
11	Weighing unit	Displays the unit of the current weighing process (model- and country-specific).
12	Activities	Opens the activities selection.
13	Print	Prints out results and/or settings (printer required).
14	Settings/preferences	Configures balance and user settings/preferences (application independent).
15	Status information field	Displays information about the system status.

3.5.3 Entering characters and numbers

The keyboard allows the user to enter characters, including letters, numbers and a range of special characters. If a barcode reader is connected to your balance and your sample provides a barcode, scan the product barcode instead of entering the designation manually (e.g. the ID can be scanned via barcode reader to ensure that the sample is clearly assigned to the corresponding product). Additionally, it is possible to connect a USB keyboard to enter the information.

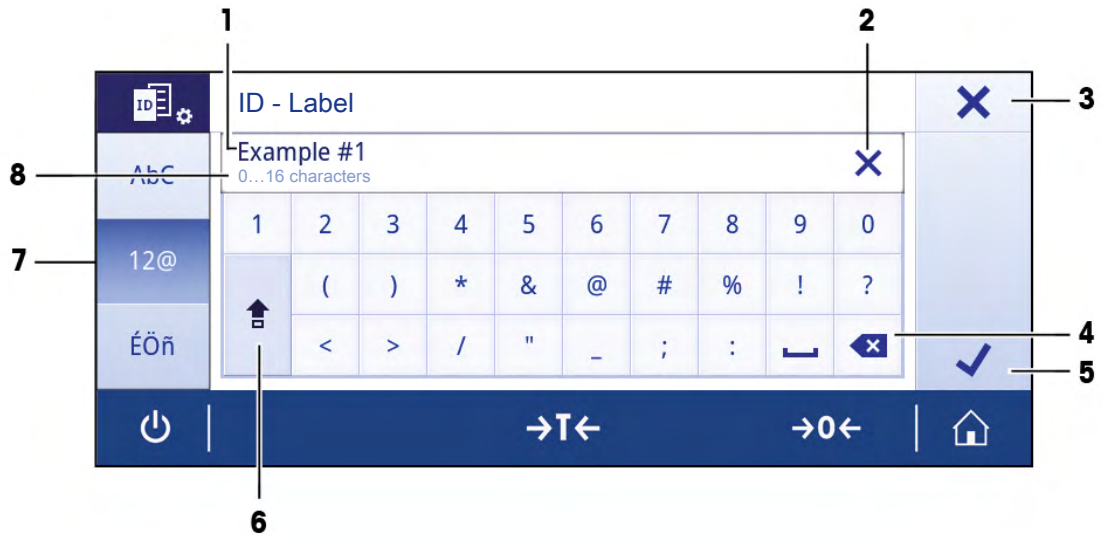

	Name	Description
1	Input field	Displays all characters that have been entered.
2	Delete all	Deletes all entered characters.
3	Discard	Discards the entered data and exits the dialog.
4	Delete	Deletes the last character.
5	Confirm	Confirms the data entered.
6	Shift	Switches between lower and upper case letters.
7	Specialized tabs	Switches keyboard mode for entering letters, numbers or special characters.
8	Explanation field	Extra information about the value to be entered.

3.5.4 Lists and tables

Navigation: ⚙️ > 🏠 **General configuration and data**

The basic elements in a simple list include a content title and a list of sub-elements. Tapping an element opens a list of sub-elements or an input dialog.

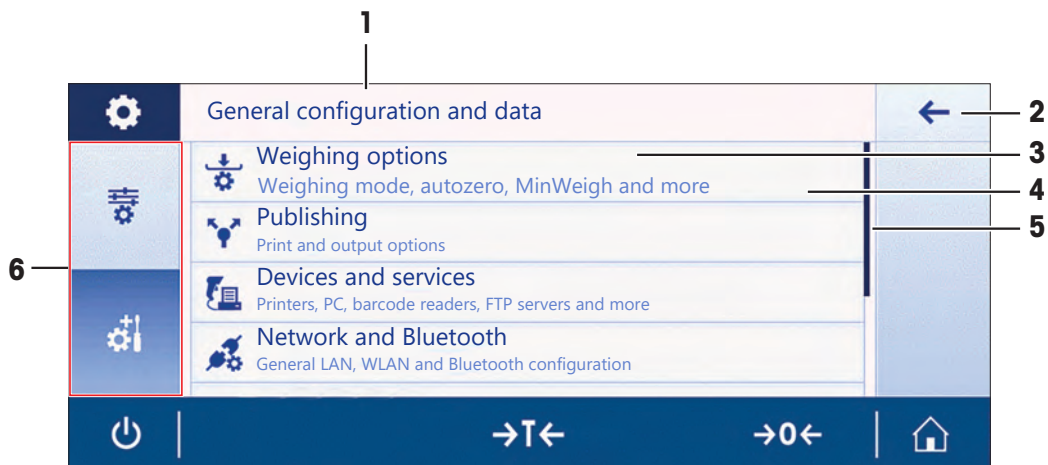

	Name	Description
1	List title	Title of the current list.
2	Back button	Moves one step back.
3	List element title	Title of the list element.
4	List element description	Displays the sub-elements.
5	Scroll position	Scrolls through the list.
6	Selection tabs	Tabs of the selectable sub-categories.

3.5.5 Basic navigation

3.5.5.1 Touch screen navigation

To interact with the balance, use the screen and the operating keys at the bottom of the screen.

Opening an application

Navigation: 🏠 > 🏠 **Activities - Weighing and other applications**

To open settings or applications, tap with your finger on the application symbol, e.g., ⚖️ **Weighing**.

There is not enough space to show all the weighing applications on one screen. Scroll horizontally to reach the applications on the second page.

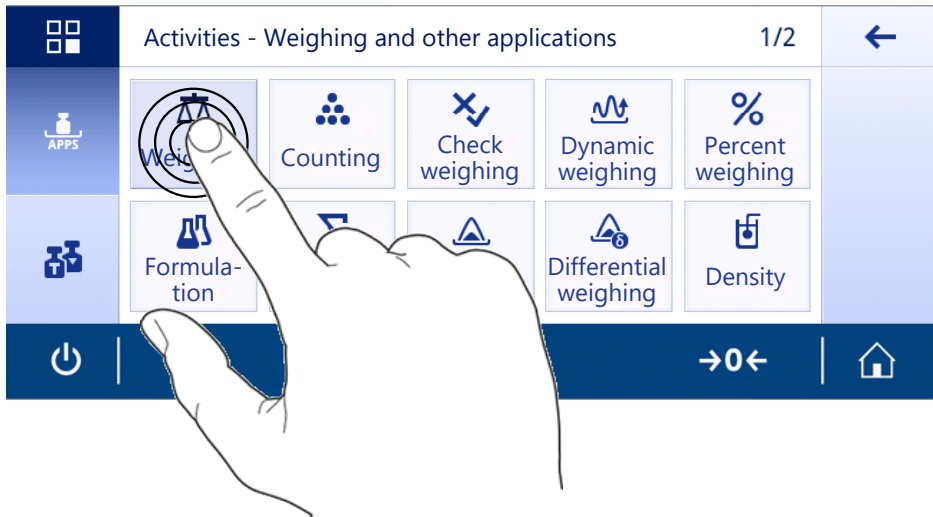

Scrolling

Navigation: ⚙️ > ⚙️ Quick settings/Preferences

When the options are too numerous to be displayed on one screen, a blue bar on the right side appears. This means that the user can scroll up and down. To scroll simply place your finger anywhere on the list and drag it up or down.

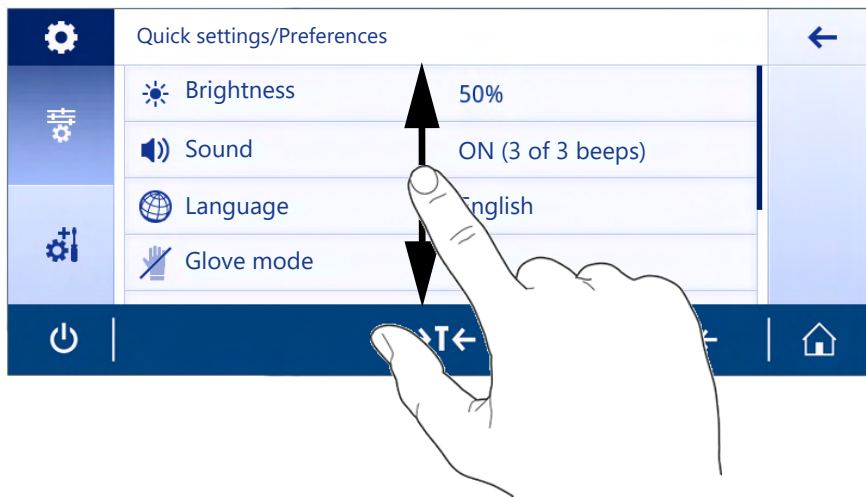

Using shortcuts

To simplify navigation on the touch screen, there are a few shortcuts that provide quick access to key areas of the balance. For example, the weighing value field on the application home screen works as a shortcut (see screen below), as does the weighing unit next to the weighing value field. Other shortcuts may be available to use depending on the application.

Every setting that can be changed directly via shortcut, can also be changed in the main configuration settings for that application.

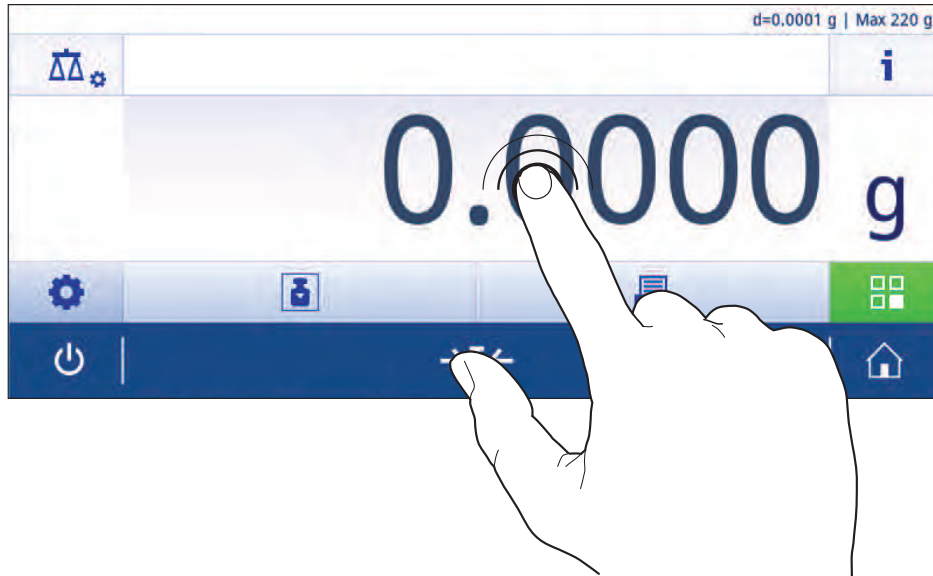

3.5.6 Detailed balance information

- Tap **i** to open the general balance information menu.

Balance identification

The balance identification section contains identification data for both hardware and software.

- Tap  to display **Balance identification**.
- ➔ The display shows the **Balance identification** as defined by the user. See [system settings ▶ Page 46] and information about the software and hardware.

Balance support information

The balance support information section contains information about last and next service checks and provides support contact information.

- Tap  to display the option **Support and service**.
- ➔ The display shows the **Service information**, **Support information** and **Quick support request**.

Quick support request

The **Quick support request** option contains a unique QR code. If you have a QR (Quick Response) code reader on your smartphone, you can take a picture of the QR code. The smartphone then creates an email with all relevant service information.

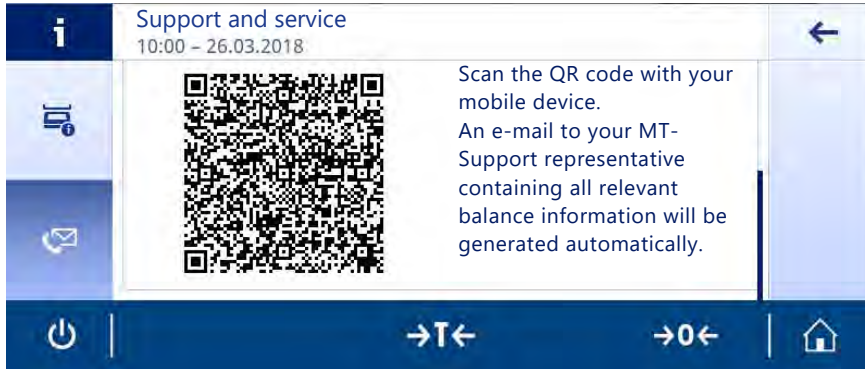

Note

Make sure the QR code can be identified by the smartphone. A program to read the QR codes must be installed beforehand. Make sure there are no access restrictions that may be able to block your email program in some way.

4 Installation and Putting into Operation

4.1 Selecting the location

A balance is a sensitive precision instrument. The location where it is placed will have a profound effect on the accuracy of the weighing results.

Requirements of the location

Place indoors on stable table

Ensure sufficient spacing

Level the instrument

Provide adequate lighting

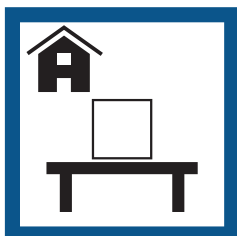

Avoid direct sunlight

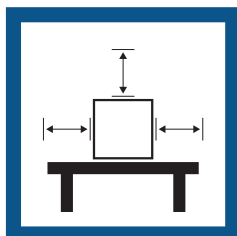
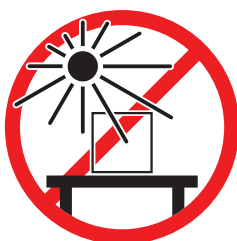

Avoid vibrations

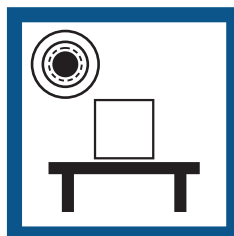
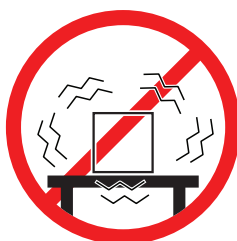

Avoid strong drafts

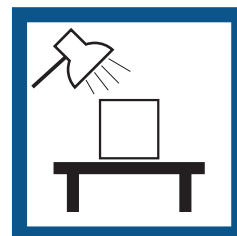

Avoid temperature fluctuations



Sufficient spacing for balances: > 15 cm all around the instrument

Take into account the environmental conditions. See "Technical Data".

4.2 Unpacking

Open the balance packaging. Check the balance for transport damage. Immediately inform a METTLER TOLEDO representative in the event of complaints or missing accessories.

Retain all parts of the packaging. This packaging offers the best possible protection for transporting the balance.

4.3 Scope of delivery

Components		0.1 mg	1 mg	10 mg	100 mg
Balance with draft shield	236 mm	✓	–	–	–
	168 mm	–	✓	–	–
Balance		–	–	✓	✓
Weighing pan	∅ 90 mm	✓	–	–	–
	127×127 mm	–	✓	–	–
	170×200 mm	–	–	✓	–
	190×226 mm	–	–	–	✓
Draft shield element		✓	–	✓	–
Pan support		✓	✓	✓	✓
Bottom plate		✓	✓	–	–
ESD plate		–	–	✓	✓
Protective cover		✓	✓	✓	✓
Universal AC/DC adapter		–	✓	✓	✓
AC/DC adapter with country-specific power cable		✓	–	–	–
User Manual		✓	✓	✓	✓
Declaration of Conformity		✓	✓	✓	✓

4.4 Assembling the balance



CAUTION



Injury due to sharp objects or broken glass

Instrument components, e.g., glass, can break and lead to injuries.

- Always proceed with focus and care.

Balances with a readability of 0.1 mg with draft shield (236 mm)

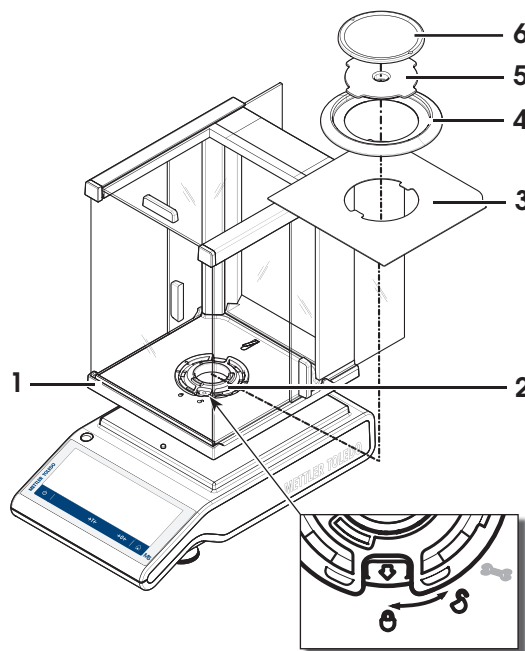

Place the following components on the balance in the specified order:

- Push the side glass doors back as far as they will go.
- 1 Hold the draft shield (1) with both hands using the bars at the top.
- 2 Turn the draft shield lock (2) to position  (unlock).
- 3 Place the draft shield on the balance.
- 4 Turn the draft shield lock to  (lock) and insert the bottom plate (3).
- 5 Insert the draft shield element (4) and weighing pan (6) with pan support (5).



Balances with a readability of 1 mg with draft shield (168 mm)

Place the following components on the balance in the specified order:

- Push the side glass doors back as far as they will go.
- 1 Hold the draft shield (1) with both hands using the bars at the top.
- 2 Turn the draft shield lock (2) to position  (unlock).
- 3 Place the draft shield on the balance.
- 4 Turn the draft shield lock to  (lock) and insert the bottom plate (3).
- 5 Insert the weighing pan (5) with pan support (4).

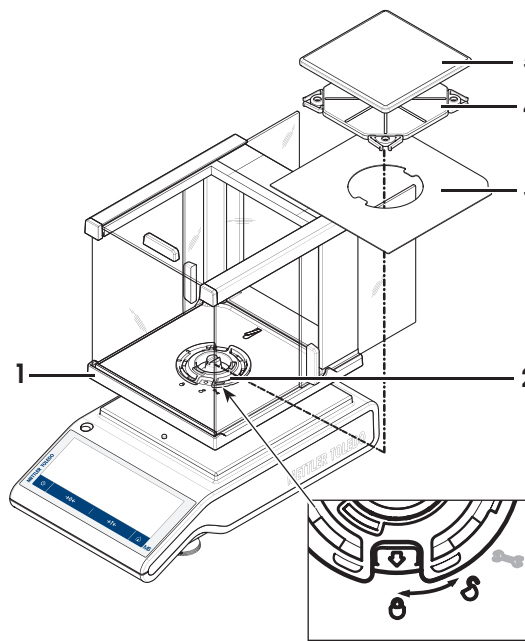

Balances with a readability of 10 mg

Place the following components on the balance in the specified order:

- ESD plate (1)
- Pan support (2)
- Weighing pan (3)
- Draft shield element (4)

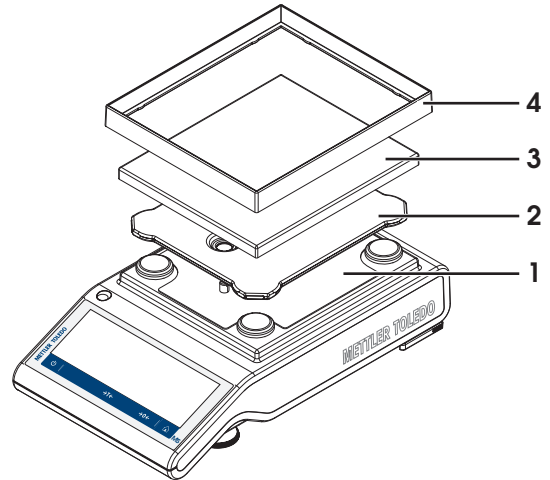

Balances with a readability of 100 mg

Place the following components on the balance in the specified order:

- ESD plate (1)
- Pan support (2)
- Weighing pan (3)

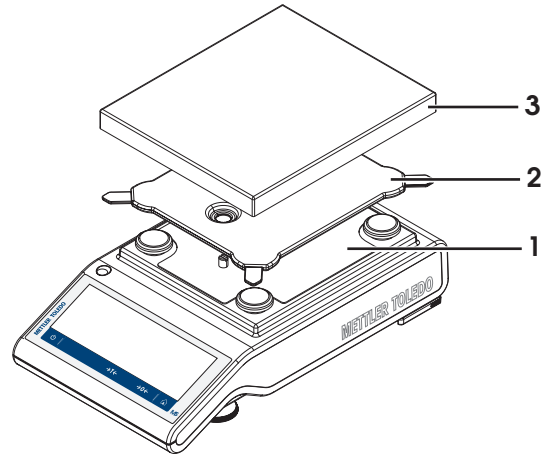

4.5 Putting into operation

4.5.1 Connecting the balance



⚠ WARNING

Death or serious injury due to electric shock

Contact with parts that carry a live current can lead to death or injury.

- 1 Only use the METTLER TOLEDO power cable and AC/DC adapter designed for your instrument.
- 2 Connect the power cable to a grounded power outlet.
- 3 Keep all electrical cables and connections away from liquids and moisture.
- 4 Check the cables and the power plug for damage and replace them if damaged.



NOTICE

Damage to the AC/DC adapter due to overheating

If the AC/DC adapter is covered or in a container, it is not sufficiently cooled and will overheat.

- 1 Do not cover the AC/DC adapter.
- 2 Do not put the AC/DC adapter in a container.

- 1 Install the cables in such a way that they cannot be damaged or interfere with operation.
 - 2 Insert the plug of the AC/DC adapter (1) in the power inlet of the instrument.
 - 3 Secure the plug by firmly tightening the knurled nut.
 - 4 Insert the plug of the power cable into a grounded power outlet that is easily accessible.
- ➔ The balance is ready for use.

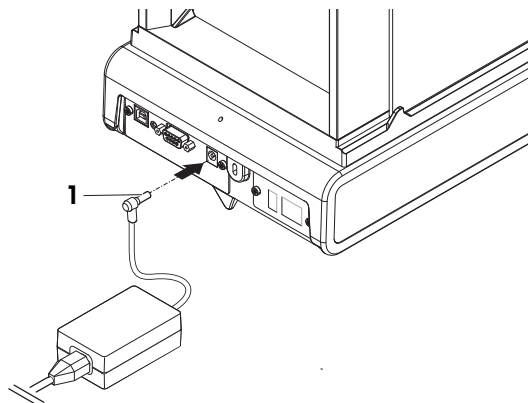

Note

Always connect the AC/DC adapter to the balance before connecting to the power.

Do not connect the instrument to a power outlet controlled by a switch. After switching on the instrument, it must warm up before giving accurate results.

4.5.2 Switching on the balance

Before using the balance, it must be warmed up in order to obtain accurate weighing results. To reach operating temperature, the balance must be connected to the power supply for at least 30 minutes (60 minutes for 0.1 mg / 0.01 mg models).

- The balance is connected to the power supply.
- The balance is warmed up.
- Press .
- ➔ After the start screen has disappeared, the application home screen will open.

When the balance is switched on for the first time, the **Weighing** application home screen will open. If the balance is switched on again, it will always start with the screen of the application last used before switching it off.

4.5.3 Changing the date and time

Navigation:  >  **General configuration and data > System settings > Date and Time**

The dialog (Picker view) allows the user to set the date and time.

Tap for **Time** and for **Date**. The format can be selected by tapping .

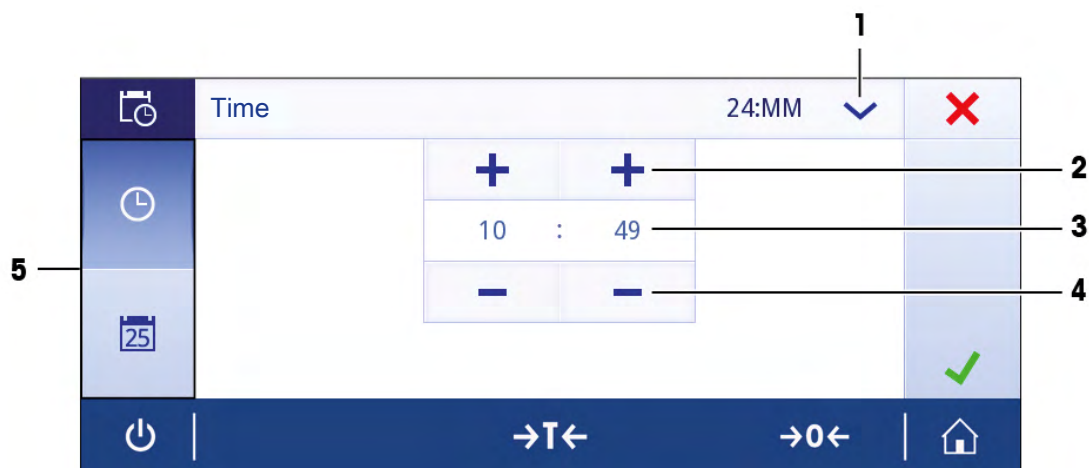

	Name	Description
1	Change date/time format	Various date/time formats can be selected.
2	Pick button	Increment.
3	Picker field	Displays the defined time/date.
4	Pick button	Decrement.
5	Selection tabs	Tabs of the selectable sub-categories.

4.5.4 Leveling the balance

Exact horizontal and stable positioning are essential for repeatable and accurate weighing results.

The balance can be levelled using the leveling assistant and/or the level indicator in front of the balance. There are two adjustable leveling feet to compensate for slight irregularities in the surface of the weighing bench.

The balance must be leveled and adjusted each time it is moved to a new location.

4.5.4.1 Leveling the balance using the level indicator

All balances have a level indicator with an air bubble that can be used level the balance manually.

Leveling balances with a readability of 0.1 mg and 1 mg

- 1 Position the balance at the selected location.
- 2 Align the balance horizontally.
- 3 Turning the two front leveling feet of the housing until the air bubble is in the middle of the glass.

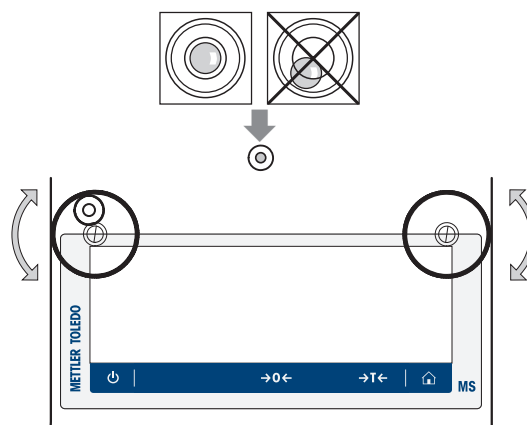

Leveling balances with a readability of 10 mg and 100 mg

- 1 Remove the clamps (1) for the safety feet by turning them outwards.
- 2 Turn the clamps (1) outwards as far as they will go (~ 90°), so that the safety feet can move freely.
- 3 Now level the balance by turning both leveling screws (2) until the bubble is in the inner circle of the level indicator (see procedure above).
- 4 Secure the safety feet by turning the clamps (1) inwards.

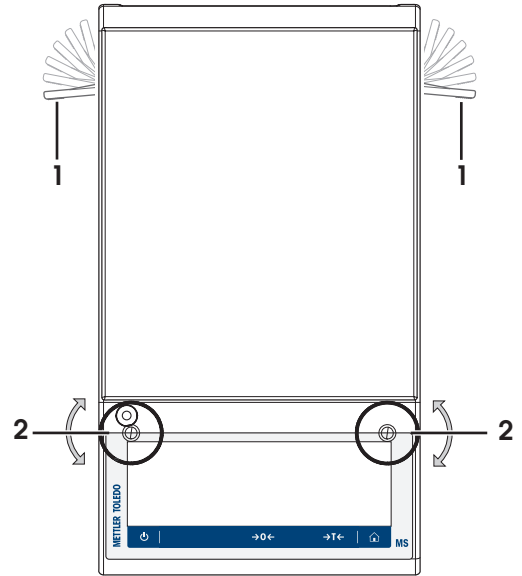

Example

Air bubble at 12 o'clock:



turn both feet clockwise.



Air bubble at 3 o'clock:



turn left foot clockwise, right foot counterclockwise.



Air bubble at 6 o'clock:



turn both feet counterclockwise.



Air bubble at 9 o'clock:



turn left foot counterclockwise, right foot clockwise.



4.5.4.2 Leveling the balance using the leveling assistant

When the balance is switched on at its new location, the symbol  **The instrument is out of level** appears in the status information field on the left of the screen.

- 1 Tap .
 - ➔ The screen **Notifications** appears.
- 2 Select **The instrument is out of level**.
 - ➔ The function **Leveling assistant** appears.

The function **Leveling assistant** is a step-by-step guide that helps to level the balance.

Navigation: ⚙️ Quick settings/Preferences > 📐 Leveling assistant

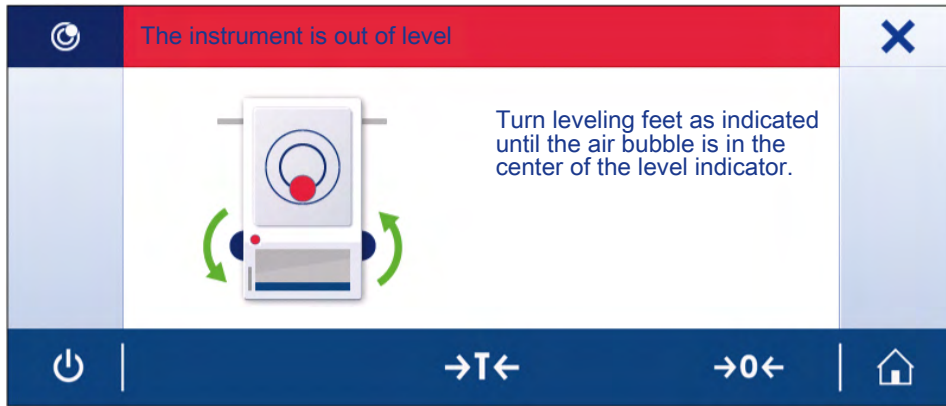

After following the instructions, the leveling assistant will display the next steps. Follow the steps until the balance is level.



Note

Always use the physical air bubble on the level indicator as a reference. If the physical air bubble is centered, but the symbol 📐 **The instrument is out of level** still appears on the screen, please consider performing a central adjustment of the level indicator. See [System settings ▶ Page 46].

4.5.5 Adjusting the balance

To obtain accurate weighing results, the balance must be adjusted to match the gravitational acceleration at its location. This is also dependent on the ambient conditions. After reaching the operating temperature, it is important to adjust the balance in the following cases:



- Before the balance is used for the first time.
- If the balance has been disconnected from the power supply or in the event of power failure.
- After significant environmental changes, e.g., temperature, humidity, air draft or vibrations.
- At regular intervals during weighing service.

4.6 Performing a simple weighing

This section describes how to perform a simple weighing operation. The basic navigation concept and the basic functions of the balance are also explained.

When you switch on the balance for the first time, the **Weighing** application home screen opens automatically. If the balance has already been used, the application that was last used before the balance was switched off will open. If another application is running, switch to **Weighing**.

Navigation:  >  **Activities - Weighing and other applications** >  **Weighing**

- 1 Press **→0←** to zero the balance.
 - ➔ The application home screen appears.
- 2 Place the sample on the weighing pan.
 - ➔ The instability symbol  appears and the value in the weighing value field becomes **light blue**.
- 3 Wait until the instability symbol  disappears and the value in the weighing value field becomes **dark blue** again.
 - ➔ The weighing process is complete.
 - ➔ The results are now displayed.

Zeroing

Use the **→0←** zeroing key before starting to weigh anything.

- 1 Unload the balance.
 - 2 Press **→0←** to zero the balance.
- ➔ All weight values are measured in relation to this zero point.

Taring

If you are working with a weighing container, tare the balance.

- 1 Place a container on the weighing pan.
 - ➔ The weight is displayed.
- 2 Press **→T←** to tare the balance.
 - ➔ **0.000 g** and **Net** appears in the display. **Net** indicates that all weight values displayed are net values.

Weighing

- Place the sample in the container.
 - ➔ The results are now displayed.
- If the container is removed from the balance, the tare weight will be shown as a negative value.
- The tare weight remains stored until the **→T←** key is pressed again or the balance is switched off.

Switching weight units

There are several weighing units available. The default value is country-specific.

The weighing unit can be selected using the main configuration of the current application or via shortcut. This example describes how to change the weighing unit via shortcut.

Legal-for-trade

With approved balances, the menu topic has a fixed setting and cannot be changed.

- 1 Tap the weighing process unit (shortcut) **gram (g)**.
 - ➔ The screen **Main unit** appears.



- 2 Place your finger somewhere on the list and swipe up to scroll down.
 - 3 Select another weighing unit, e.g., **ounce (oz)** by tapping it.
 - 4 Tap ✓ to confirm.
- ➔ The weighing unit **gram (g)** has now been changed to **ounce (oz)**.

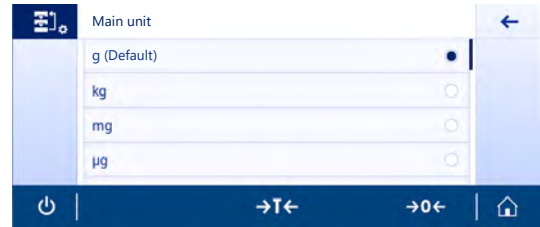

Changing the readability

There are several readabilities available. The default readability (d) is model-specific.

- 1 Tap the weighing value field.



- 2 Tap **10d - 0.001 g**.
 - 3 Confirm the selected readability by tapping ✓.
- ➔ The readability has now been changed.



Print / transmit data

The balance can send data to a printer or a PC. Press the  key to transmit the weighing results or settings via the interface. The procedure for activating and configuring a printer is described in "Publishing" and "Devices and services".

- Printer is connected to the balance.
 - Printer is switched on.
 - Printer is activated and configured.
- Tap .
- ➔ The data are transmitted.

Switching off

- 1 Press and hold  until the dialog **Switch-off** appears.
 - 2 Tap ✓ to confirm.
 - ➔ The balance switches off and enters standby mode.
- After switching on from standby mode, the balance does not need to warm up. It is immediately ready to start weighing.
 - If the balance has been switched off manually, the display will also be off.
- To switch off the balance fully, it must be disconnected from the power supply.

4.7 Transporting, packaging and storage



CAUTION

Injury due to sharp objects or broken glass

Instrument components, e.g., glass, can break and lead to injuries.

- Always proceed with focus and care.

- 1 Press and hold the  key.
- 2 Disconnect the balance from the AC/DC adapter.
- 3 Disconnect all interface cables.

4.7.1 Transporting over short distances

To move the balance over a short distance to a new location, follow the instructions below.

- 1 Hold the balance with both hands as shown.
- 2 Carefully lift the balance and carry the balance in horizontal position to the new location.

If you want the balance put into operation, proceed as follows:

- 1 Connect in reverse order.
- 2 Level the balance.
- 3 Perform an internal adjustment.

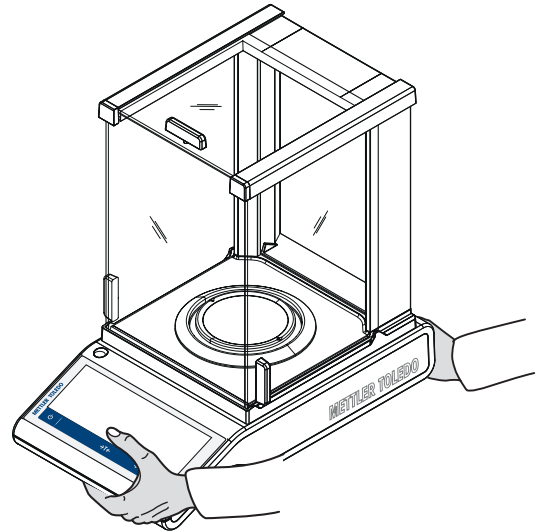

4.7.2 Transporting over long distances

METTLER TOLEDO recommends using the original packaging for transportation or shipment of the balance or balance components over long distances. The elements of the original packaging are developed specifically for the balance and its components and ensure maximum protection during transportation.

4.7.3 Packaging and storage

Packaging

Store all parts of packaging in a safe place. The elements of the original packaging are developed specifically for the balance and its components to ensure maximum protection during transportation or storing.

Storage

Store the balance under following conditions:

- Indoor and in the original packaging.
- According to the environmental condition, see "Technical data".
- When storing for longer than six months, the rechargeable battery maybe down (date and time get lost).

4.8 Weighing below the balance

Your balance is equipped with a weighing hook for performing weighing operations below the work surface (weighing below the balance).



Note

Models with a glass draft shield: carefully lift the draft shield from the weighing platform and put it aside.

- 1 Press and hold the  key.
- 2 Disconnect the balance from the AC/DC adapter.
- 3 Disconnect all interface cables.
- 1 Remove the draft ring element (for 10 mg and 100 mg models).
- 2 Remove weighing pan and pan support.
- 3 Remove the bottom plate and unlock the draft shield (models with draft shield). Carefully lift the draft shield from the weighing platform and put it aside.
- 4 **NOTICE: Damage to the instrument. Do not place the instrument on the pan support location bolt.** Turn the balance carefully on its side.
- 5 Remove and retain the 2 screws (1) and the weighing hook cover (2). The weighing hook is now accessible.
- 6 Turn the balance to its usual position and simply reinstall all components in the reverse order.

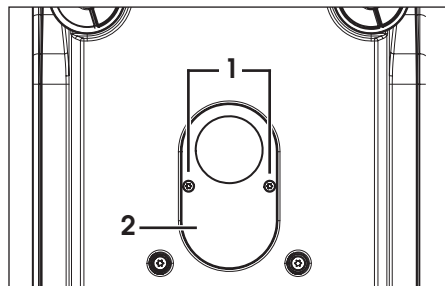

5 General Settings

Navigation:

This section describes the procedure for adapting the balance to suit specific requirements. The settings apply to the entire weighing system and therefore to all applications.

The section **Settings** is divided into two sub-sections:

-  **Quick settings/Preferences**
-  **General configuration and data**

All settings and configuration data can be printed out.

■ Printer is connected and configured.

1 Tap .

➔ The screen **Print and export report** appears.

2 Select the settings, e.g., **Quick settings/Preferences** and **Weighing options** for printing and confirm with .

➔ A list of the selected settings will be printed.

The following options can be set:









Parameter	Description	Values
Print	Select the settings for printing.	Quick settings/ Preferences* Weighing options* Publishing* Devices and connec- tivity* Network and Bluetooth* System settings* User management* ISO-Log – Adjustments ISO-Log – Balance ISO-Log – Settings and status ISO-Log – Activity fails

* Factory setting

5.1 Quick settings/Preferences

Navigation: > **Quick settings/Preferences**

The following options are available:

-  **Brightness**
-  **Sound**
-  **Language**
-  **Glove mode**
-  **Quick adjustment**
-  **Date/Time widget**
-  **Leveling assistant**
-  **Change user password...** (only if **User management** is activated)

5.1.1 Brightness

Navigation: > **Quick settings/Preferences** > **Brightness**

This menu item can be used to adjust the display brightness. Each time you tap the bar, the brightness adjusts in increments of 10%.

The following options can be set:

Parameter	Description	Values
Brightness	Sets the brightness of the display (in 10% increments).	10...100% (80%*)

* Factory setting

5.1.2 Sound

Navigation:  >  **Quick settings/Preferences** >  **Sound**

This menu item can be used to adjust the sound and the sound volume.

The following options can be set:

Parameter	Description	Values
Stability beep	Indicates when an unstable weight becomes stable.	OFF Low* Medium High
Workflow feedback beep	Provides additional feedback in the event of input errors, messages and status notifications.	OFF Low* Medium High
Touch beep	Notifies every touch of the interactive elements on the touch display and zero/tare bar.	OFF* Low Medium High

* Factory setting

5.1.3 Language

Navigation:  >  **Quick settings/Preferences** >  **Language**

This menu item can be used to set the dialog language. The language changes immediately. All windows and messages are displayed in the selected language.

The following options can be set:

Parameter	Description	Values
Language	Sets the preferred language. The language is normally preset for the country of use.	English Deutsch Français Español Italiano Русский Polski Český Magyar Nederlands Português PT. Português BRA. Türkçe 中文 日本語 한국어

5.1.4 Glove mode

Navigation:  >  **Quick settings/Preferences** >  **Glove mode**

If **Glove mode** activated, the touch screen becomes more sensitive and easier to navigate when wearing gloves.

The following options can be set:

Parameter	Description	Values
Glove mode	Activates or deactivates the function Glove mode .	ON OFF*

* Factory setting

5.1.5 Quick adjustment

Navigation:  >  **Quick settings/Preferences** >  **Quick adjustment**

If **Quick adjustment** is activated, the symbol  appears in the main navigation of the application. You can start the adjustment directly from the work area.

The following options can be set:

Parameter	Description	Values
Quick adjustment	Activates or deactivates Quick adjustment .	ON* OFF
	Starts the adjustment directly from work area.	Internal adjustment (model-specific) External adjustment

5.1.6 Date/Time widget

Navigation:  >  **Quick settings/Preferences** >  **Date/Time widget**

This option can be activated to permanently display the current date and time in the work area in the value bar above the weighing value field.

The following options can be set:

Parameter	Description	Values
Date/Time widget	Activates or deactivates the permanent display of the current date and time in the work area.	ON OFF*

* Factory setting

5.1.7 Leveling assistant

Navigation:  >  **Quick settings/Preferences** >  **Leveling assistant**







The function **Leveling assistant** helps to adjust the balance, e.g., if the balance has changed location.

For more information, see [Leveling the balance ▶ Page 24].

5.1.8 Change user password

Navigation:  >  Quick settings/Preferences >  Change user password...







If user management is activated and the user is protected with a password, the user password can be changed in this section.

- 1 Tap  **Change user password...**
 - ➔ The screen **Old password** appears.
- 2 Enter the password and confirm with .
- 3 The screen **New password** appears.
- 4 Enter the password and confirm with .
- ➔ The screen **Confirm password** appears.
- 5 Enter the password again and confirm with .
- ➔ The screen **Password changed** appears.
- 6 Tap  to confirm.
- 7 Tap  to return to the application screen.

5.2 General configuration and data

Navigation:  >  General configuration and data

The following options are available:

-  **Weighing options**
-  **Publishing**
-  **Devices and services**
-  **Network and Bluetooth**
-  **System settings**
-  **User management**
-  **ISO-Log**

5.2.1 Weighing options

Navigation:  >  General configuration and data >  Weighing options

This menu item can be used to adapt the balance to suit specific requirements.

5.2.1.1 Weighing mode

Navigation:  >  General configuration and data >  Weighing options > Weighing mode

This setting can be used to configure the balance to the weighing mode.

The following options can be set:

Parameter	Description	Values
Weighing mode	Sets the weighing mode. Universal = for all standard weighing applications. Dosing = for dosing liquid or powdery samples.	Universal* Dosing

* Factory setting

5.2.1.2 Environment

Navigation:  >  General configuration and data >  Weighing options > Environment

This setting is used to adapt the balance optimally to the ambient conditions at specific locations.

The following options can be set:

Parameter	Description	Values
Environment	Sets the ambient conditions.	Stable Standard* Unstable Very unstable

* Factory setting

5.2.1.3 Autozero

Navigation:  >  **General configuration and data** >  **Weighing options** > **Autozero**

This menu item can be used to switch the automatic zero correction **ON** or **OFF**. It corrects the zero deviation, that may occur, e.g., due to slight fouling of the weighing pan.

Legal-for-trade

The **Autozero** cannot be deactivated for approved balances (except for some selected countries).

The following options can be set:

Parameter	Description	Values
Autozero	Activates or deactivates the automatic zero correction.	ON* OFF

* Factory setting

5.2.1.4 Auto tare

Navigation:  >  **General configuration and data** >  **Weighing options** > **Auto tare**

This automatically tares the first weight loaded on the empty weighing pan. This function applies to all applications except for **Formulation**, **Differential weighing** and **Back-weighing**.

The following options can be set:

Parameter	Description	Values
Auto tare	Activates or deactivates the auto tare function.	ON OFF*

* Factory setting

5.2.1.5 Auto clear tare

Navigation:  >  **General configuration and data** >  **Weighing options** > **Auto clear tare**

If **Auto clear tare** activated, the current tare is automatically cleared after removing all loaded weight from the weighing pan. This function applies to all applications except for **Formulation**, **Differential weighing** and **Back-weighing**.

The following options can be set:

Parameter	Description	Values
Auto clear tare	Activates or deactivates the auto clear tare function.	ON OFF*

* Factory setting

5.2.1.6 MinWeigh

Navigation:  >  **General configuration and data** >  **Weighing options** > **MinWeigh**

The **MinWeigh method** function notifies when a measurement value does not meet the required weighing accuracy. The usage of MinWeigh is application-specific (contextual settings).

Setting the **MinWeigh method**

- 1 Tap **MinWeigh**.
 - ➔ The screen **MinWeigh configuration** appears.
- 2 Tap **MinWeigh method**.
 - ➔ The screen **MinWeigh method** appears.
- 3 Select method and confirm with ✓.
 - ➔ The screen **MinWeigh configuration** appears.
- 4 Tap **Minimum weight**.
 - ➔ The dialog screen **Minimum weight in g** appears.
- 5 Enter the weight for the minimum weight and confirm with ✓.
 - ➔ The screen **MinWeigh configuration** appears.
- 6 Tap ✓ to return to the previous screen.

The following options can be set:

Parameter	Description	Values
MinWeigh	Activates or deactivates the MinWeigh method.	Not defined*
	Sets the MinWeigh method.	Customized Certificate

* Factory setting

The selectable options in the dialog **MinWeigh configuration** vary depending on the chosen method.

The following methods are available:

- **Customized**
- **Certificate**
- **OIML**

Legal-for-trade

The **OIML** method is only available for approved balances.

5.2.1.7 Recall

Navigation:  >  **General configuration and data** >  **Weighing options** > **Recall**

To retain and recall the last stable weight.

The following options can be set:

Parameter	Description	Values
Recall	Activates or deactivates recall.	ON OFF*

* Factory setting

5.2.2 Publishing

Navigation:  >  **General configuration and data** >  **Publishing**

The publishing options can be defined individually for all corresponding receiving devices/services available in the general settings area "Devices and services".

Define which work output you want to produce, in which ways and in which format.

The available options may vary depending on the peripheral device connected and configured in "Devices and services". Not every option described is available for the selected peripheral.

The publishing menu is structured in the following sections:

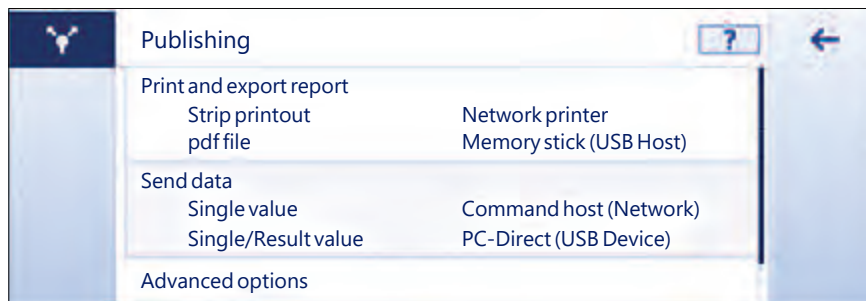

- **Print and export report**
- **Send data**
- **Advanced options**



5.2.2.1 Print and export report

Navigation:  >  **General configuration and data** >  **Publishing** > **Print and export report**

The following sections are available. While the main configuration is always available, the print report and export report file(s) are only available depending if a device/service is setup.

-  **General configuration**
-  **Print report**
-  **Export report file**

Print and export – General configuration 

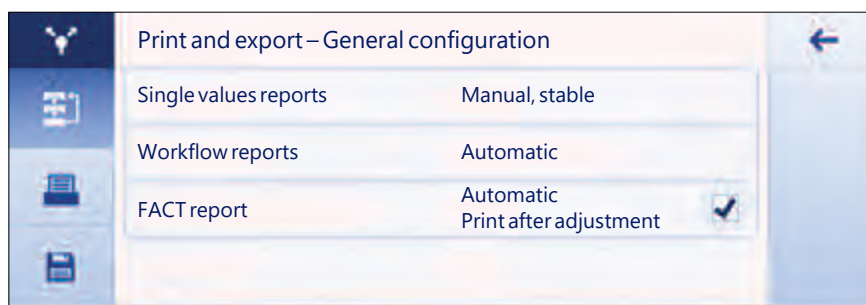

The following options can be set, which are valid for both the **Print report** and the **Export report file**.

Parameter	Description	Values
Single values reports	Sets the behaviour of the printer for single values.	Manual, stable* Manual, all values Automatic, stable Automatic, stable (zero included)

Workflow reports	Sets the workflow for the reports. Automatic = the report is printed at the end of the workflow automatically. Manual = the report is printed at will.	Automatic* Manual
FACT report	Defines whether the FACT report is being printed automatically.	Automatic* OFF

* Factory setting

Depending on the application the behavior, when a report/result is published, can be different.

- Single values reports (S): Each generated weight value can be manually or is automatically published
 - Weighing
 - Counting
 - Check weighing
 - Dynamic weighing
 - Percent weighing
 - Factor weighing
- Workflow reports (W): Several weight values are stored during a workflow within the application and the final result can be manually or is automatically published at the very end of the workflow.
 - Formulation
 - Totaling
 - Back-weighing
 - Differential weighing
 - Density
 - Adjustment and tests

An example workflow of how a report could be set up correctly to publish the data is shown below. As a prerequisite, the device/service needs to be configured correctly beforehand in **Devices and services**.

- 1 Tap **Print and export report**.
 - ➔ The screen **Print and export – General configuration** appears.
- 2 Tap **Single values reports**.
 - ➔ The screen **Single values reports** appears.
- 3 Select, e.g., **Automatic, stable** and confirm with ✓.
 - ➔ The next stable weight is automatically printed and/or exported.
- 4 Tap **Workflow reports**.
 - ➔ The screen **Workflow reports** appears.
- 5 Select, e.g., **Automatic** and confirm with ✓.
 - ➔ The workflow report is automatically printed and/or exported.

Print report

Print out manually or automatically application, adjustment and test results on strip paper.

The following options can be set:

Parameter	Description	Values
Printout type	Activates or deactivates the printer.	ON* OFF

Export report file

Export the weighing results and additional data according the report configuration in each application to a USB memory stick (PDF, XML, CSV or TXT file) or a FTP file server (PDF or XML file).

Please be aware the content of the file is always defined in the report configuration of each application (for more details go to section reports configuration). It is recommended not to publish PDF files in shorter intervals than 10 seconds, as creating the PDF file takes a certain time.

The following options can be set:

Parameter	Description	Values
File type	Defines the file type for export. Each result generates a new PDF or XML file. However, for CSV files in single value reports (e.g., Weighing) all measurement results are stored in the same file, as long as the application, the user or any meta data is not changed.	pdf xml csv txt Depending on export mode.
File language (pdf)	Describes in which language the PDF report is generated. The report is generated in the language of the preference settings (if available) or English.	English Deutsch Français Español Italiano not selectable
File name	Activates or deactivates the Standard (Activity name) file name. Custom... = defines the file name (max. 16 characters).	Standard (Default)* Custom...
Date/Time of file creation	Activates or deactivates the date/time of the file creation at the end or beginning of the report.	ON* OFF Add at the end* Add at the beginning
File location	Describes the location on the USB memory stick or FTP server.	any Create a folder for the publication, e.g., "METTLER TOLEDO\Reports" on the storage device. The corresponding file will be saved in the created folder.

Below an example how to configure the publishing option to export a PDF file to USB memory stick which has to be attached.

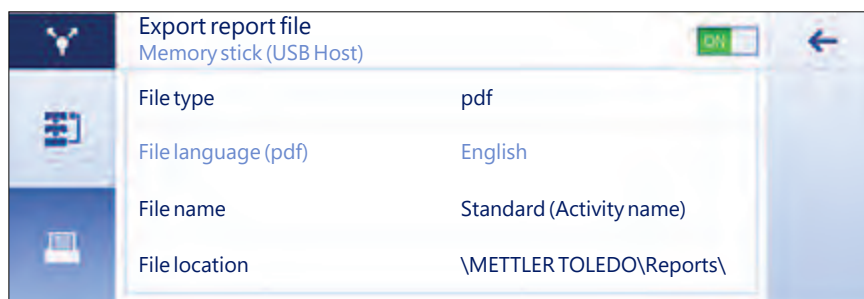

- 1 Tap **Export report file**.
 - ➔ The screen **Export report file** appears.
- 2 Tap **File type**.
 - ➔ The screen **File type** appears.
- 3 Select, e.g., **pdf** and confirm with ✓.
- 4 Tap **File name**.
 - ➔ The screen **File name** appears.
- 5 Select, e.g., **Custom...** by tapping.
 - ➔ The screen **File name** appears.
- 6 Enter a name and confirm with ✓.
- 7 Tap ✓ to confirm.
 - ➔ The screen **Date/Time of file creation** appears.
- 8 Activate, e.g., **Add at the beginning** and confirm with ✓.

➔ The data and time is printed at the beginning of the report.

9 Tap **File location**.

➔ The screen **File location** appears.

10 Enter a name for the path of the storage folder and confirm with ✓.

11 Tap ✓ to confirm.

5.2.2.2 Send data

Navigation: ⚙️ > 🏠 **General configuration and data** > 📡 **Publishing** > **Send data**

Send manually or automatically single weight- or result values to a PC with the PC-Direct, EasyDirect Balance or Command host service via RS232, USB or LAN/WLAN. We do not recommend to use WLAN in the mode automatic/continuous.

For more information about PC-Direct, EasyDirect Balance and Command host and how to set it up, please refer to "Devices and Services".

The following options can be set for PC-Direct, EasyDirect Balance and the Command host service.

PC-Direct or EasyDirect Balance

Parameter	Description	
ON* OFF	Activates or deactivates the option send data.	
Single values	Send next stable weight.	Manual, stable* Manual, all values Automatic, stable (zero excluded) Automatic, stable (zero included)
Result values	Send result value. Automatic = the result is sent on finishing automatically. Manual = the result is sent at will.	Automatic* Manual

* Factory setting

Command host

Parameter	Description
ON* OFF	Activates or deactivates the option send data.
Manual, stable*	Send next stable weight at will
Manual, all values	Send any stable or unstable weight at will
Automatic, stable	Send next stable weight automatically The next stable weight is sent after a minimal deviation, see table relationship between readability and deviation below.
Automatic, continuous	Send any stable or unstable weight automatically. (The weight value is sent with an update rate of 22.9 per seconds).

* Factory setting

Stability criteria: Relationship between readability and deviation

Readability	Min. deviation
0.1 mg	0.1 g
0.001 g	1 g
0.01 g	1 g
0.1 g	1 g
1 g	5 g

5.2.2.3 Advanced options

Navigation: > **General configuration and data** > **Publishing** > **Advanced options**

The following options can be set:

Parameter	Description	Values
Autopublish	Activates or deactivates the publishing time interval.	ON OFF*
	Sets the publishing time interval of single values. Please be aware that exporting a file to a USB memory stick or a FTP server takes some time and we therefore do not recommend to set this value in these cases below 10 seconds.	numerical values (1... 65535 seconds)
Commands options	Activates or deactivates the function Print and tare . The balance will tare automatically after publishing.	ON OFF*

* Factory setting

5.2.3 Devices and services

Navigation: > **General configuration and data** > **Devices and services**

Add and configure up to 5 specific devices and services, e.g., printer for RS232, barcode reader for USB or FTP server for WLAN. Added **Devices and services** can be temporarily made unavailable for usage (turn **OFF**).

Before adding devices or services using network or Bluetooth make sure that LAN, WLAN or Bluetooth are available and correctly configured and that Bluetooth devices are discoverable and in range. Please compare **Network and Bluetooth** in **General configuration and data**.

Only one device/service set up per interface is possible. On creating a new device/service the existing will be replaced. The last saved configuration of the replaced device will be used as default when the same device type is added again at a later time.

The following devices and services can be added and configured via the different interfaces.

Parameter	Description	Values
P-20	Connect to a Standard lab printer.	RS232* USB Host
P-52	Connect to a Excellence lab printer (Dot-matrix technology).	RS232 USB Host LAN/WLAN Bluetooth
P-56/58	Connect to a Excellence lab printer (Direct thermal technology).	RS232 USB Host LAN/WLAN Bluetooth
Printer	Connect to a custom printer.	RS232
Barcode reader	Connect to a barcode reader.	RS232 USB Host
Keyboard	Connect a wired USB keyboard. Only few wireless keyboards with a USB/Bluetooth converter working according USB HID class are supported (e.g., Logitech K270).	USB Host
Second display	Connect a auxiliary weight display. Note: If you select Second display make sure that no other device is connected at RS232. Other devices could be damaged because of the voltage.	RS232
Memory stick	Connect a USB memory stick. Please use a high-quality USB Memory stick, which is FAT32 formatted and empty for reliable operation. Wait at least 10 seconds after the last transaction, before you remove the USB memory stick.	USB Host
PC-Direct	Establishes a service to send the weight value to a PC. E.g., to Microsoft Excel by placing the cursor in the required cell. PC-Direct sends the weight value like a numeric keypad. Please make sure the NumLock is on. Via the USB device interface there is no additional software on the PC needed except a METTLER TOLEDO USB driver.	RS232 USB Device



EasyDirect Balance	Establish this service to send measurement and device data to the METTLER TOLEDO data management software EasyDirect Balance running on a PC (www.mt.com/EasyDirectBalance). To benefit from the full functionality, please connect the balance via the LAN interface. We do not recommend to use EasyDirect Balance if the balance is connected to the WLAN only.	RS232 LAN
File server (FTP)	Establishes the service to connect to a FTP Server.	Network: LAN/WLAN
Web access	Web access enables you to connect your balance to any web browser on your tablet or PC. You can view results and perform basic balance operations (e.g., tare, print) from anywhere.	Network: LAN/WLAN
Command host	Establish the Command host service to communicate with the balance via MT-SICS.	RS232 USB Device* Network: LAN/WLAN

* Factory setting

Adding a new device or service

By default a P-20 printer on RS232 and the command host service on USB device are already available. To add other or more devices and services there are two possibilities:

Adding a new device/service via the menu **General configuration and data > Devices and services**.

- 1 Tap .
- 2 Select the required device/service.
- 3 By following the step-by-step guidance the correct connection/interface is selected and the device and interface specific configuration parameters can be set. At the very end of the process all settings need to be confirmed and saved by pressing .

For printers there is the possibility to check if everything is working correctly by pressing  when re-entering into the printer configuration.

Adding devices via USB Host

By connecting, e.g., a printer on the USB host interface, the balance recognizes the new device and adds it automatically to the devices and service list. If the balance needs any additional information regarding the settings the new device symbol will blink in the home screen. In any case please check the settings of the new device/service by going into **General configuration and data > Devices and services** and press on the newly added device/service. Before adding a printer via USB host, please make sure it is powered on correctly. Otherwise, it will not be recognized by the balance.

Deactivating or deleting a device/service

A device/service can be deactivated any time by switching them off in the device configuration **General configuration and data > Devices and services**.

Press the device/service you would like to deactivate and change the on/off switch to **OFF**.

To delete a device go to **General configuration and data > Devices and services** press  and select the device/service you would like to remove and confirm with .



Note

Please also consult **Publishing** and **Reports configuration** for further information.

RS232

The following options can be set depending on the connected device or service:

Parameter	Description
Command set	MT-SICS* MT-PM Sartorius 22 Sartorius 16 MT-SICS = MT-SICS data transfer format is used. MT-PM = emulates the data format of PM balances. Sartorius 22/Sartorius 16 = emulates the data format of Sartorius balances.
Baudrate	600 1200 2400 4800 9600* 19200 38400 57600 115200 (available values are device-specific)

Bit/Parity	8/No* 7/No 7/Mark 7/Space 7/Even 7/Odd
Stop bits	1 bit* 2 bits
Handshake	Xon/Xoff* RTS/CTS None
Character set	IBM/DOS ANSI/WIN UTF-8* UTF-8 = is a character encoding capable of encoding all possible characters, or code points, defined by unicode (device-specific).
End of line	<CR><LF>* <CR> <LF> <TAB> <CR><LF> = writes in the same column, e.g., in Excel. <TAB> = writes in the same row, e.g., in Excel.

* Factory setting

USB Device (type B)

The following options can be set depending on the connected device or service:

Parameter	Description
Command set	MT-SICS* MT-PM Sartorius 22 Sartorius 16 MT-SICS = MT-SICS data transfer format is used. MT-PM = emulates the data format of PM balances. Sartorius 22/Sartorius 16 = emulates the data format of Sartorius balances.
Character set	ANSI/WIN UTF-8 Cannot be changed (device-specific).
End of line	<CR><LF>* <CR> <LF> <TAB> <CR><LF> = writes in the same column, e.g., in Excel. <TAB> = writes in the same row, e.g., in Excel.

* Factory setting

USB Host (type A)

The following options can be set depending on the connected device or service:

Parameter	Description
Character set	IBM/DOS ANSI/WIN UTF-8* UTF-8 = is a character encoding capable of encoding all possible characters, or code points, defined by unicode (device-specific).
End of line	<CR><LF>* <CR> <LF>

* Factory setting

Bluetooth

The following options can be set depending on the connected device or service:

Parameter	Description
Connection type	not selectable
Device name	Select the device to be configured.
Character set	UTF-8 UTF-8 = is a character encoding capable of encoding all possible characters, or code points, defined by unicode (device-specific).
End of line	<CR><LF>

LAN / WLAN

The following options can be set depending on the connected device or service:

Parameter	Description
Connection type	not selectable

IP address	Defines the IP address of the device.
Port	Defines the device port.
Command set	MT-SICS* MT-PM Sartorius 22 Sartorius 16 MT-SICS = MT-SICS data transfer format is used. MT-PM = emulates the data format of PM balances. Sartorius 22/Sartorius 16 = emulates the data format of Sartorius balances.
Character set	ANSI/WIN UTF-8*
End of line	<CR><LF>* <CR> <LF> <TAB> <CR><LF> = writes in the same column, e.g., in Excel. <TAB> = writes in the same row, e.g., in Excel.

* Factory setting

5.2.4 Network and Bluetooth

Navigation:  >  **General configuration and data** >  **Network and Bluetooth**

In the menu **Network and Bluetooth** the LAN, WLAN or Bluetooth connections are set up and configured. Once the general connection is established the interface specific devices and services are added and configured in the general settings area **Devices and services**.

For wireless communication (WLAN and Bluetooth) a METTLER TOLEDO wireless dongle (MTICWD-100) is needed; WLAN and Bluetooth are only listed in the menu, when the wireless dongle is connected to the balance. Please contact your METTLER TOLEDO-sales representative for more information.

For installing and configuring a LAN/WLAN you need to have basic knowledge of TCP/IP-based networks and of network technology in general. If necessary, contact the network administrator of your IT department or your IT support.



Note

While WLAN and Bluetooth can be activate simultaneously, LAN and WLAN are exclusive. E.g., when switching WLAN on, an existing LAN connection is switched off automatically.

The section has the following sub-sections:

-  **LAN**
-  **WLAN**
-  **Bluetooth**

LAN

Ethernet interface for connecting the instrument to a TCP/IP network. The most simple network can be implemented by connecting the instrument directly to the PC with a cross-over cable (RJ45 socket).

We recommend to use the default setting DHCP (automatic network settings).

The following options can be set:



Parameter	Description	Values
Configuration mode	Defines the parameter for the WLAN connection. DHCP = the parameters for the Ethernet connection will be automatically set. Manual = the options for the Ethernet connection must be set manually by the user.	DHCP* Manual
IP address	If the IP is not to be automatically obtained, you can enter it here.	000.000.000.000 ... 255.255.255.255
Subnet	Defines the subnet mask that is used by the TCP/IP protocol to determine whether a host is on the local subnet or on a remote network.	000.000.000.000 ... 255.255.255.255

Standard Gateway	Defines the address of the standard gateway that links the host's subnet to other networks.	000.000.000.000 ... 255.255.255.255
MAC-Address	Information on the MAC address (Media Access Control) that is used to uniquely identify the balance in the network.	not selectable

* Factory setting

Connecting LAN automatically (DHCP)

- Balance is connected via a Ethernet cable to the LAN.

- 1 Tap  **LAN**.
 - ➔ The screen **LAN** appears.
- 2 Tap **ON** to activate **LAN** and confirm with .
 - ➔ LAN connection is established.

WLAN

The following options can be set:

Parameter	Description	Values
No network connected	Select a network or search for a non-visible one. Please repeat the network search  , if the network you are looking for is not listed initially.	
Configuration mode	Defines the parameter for the WLAN connection. DHCP = the parameters for the Ethernet connection will be automatically set. Manual = the options for the Ethernet connection must be set manually by the user.	DHCP* Manual
IP address	If the IP is not to be automatically obtained, you can enter it here.	000.000.000.000 ... 255.255.255.255
Subnet	Defines the subnet mask that is used by the TCP/IP protocol to determine whether a host is on the local subnet or on a remote network.	000.000.000.000 ... 255.255.255.255
Standard Gateway	Defines the address of the standard gateway that links the host's subnet to other networks.	000.000.000.000 ... 255.255.255.255
MAC-Address	Information on the MAC address (Media Access Control) that is used to uniquely identify the balance in the network.	not selectable



Bluetooth

The following options can be set:

Parameter	Description	Values
Bluetooth identification	With this identification the balance is shown to other Bluetooth devices.	Freely configurable (balance model name*)
Secure mode	Activates or deactivates the secure mode.	ON* OFF

* Factory setting

- Wireless dongle MTICWD-100 is connected to USB Host interface.

- 1 Tap  **Bluetooth**.
 - ➔ The screen **Bluetooth** appears.
 - 2 Tap **ON** and confirm with .
 - ➔ The screen **Network and Bluetooth** appears.
- ➔ **Bluetooth** is available.

5.2.5 System settings

Navigation:  >  **General configuration and data** >  **System settings**

This section describes the procedure for adapting the balance to suit specific requirements.

The following standard options can be set:

Parameter	Description	Values
Date and Time	Sets the time format and the date. The format can be selected by tapping  .	Time: 24:MM* 12:MM 24.MM 12.MM Date: DD.MM.YYYY* D.MMM YYYY MM/DD/YYYY MMM DD YYYY YYYY-MM-DD YYYY/MM/DD
Balance identification	Defines a balance identification. By default the balance identification consists of the balance model and the serial number.	Values can be defined individually.
Sleep mode	Activates or deactivates the screen saver.	ON* OFF
	Determines when the screen saver appears with date and time. Tap on the screen to exit the screen saver.	After 30 seconds After 1 minute After 2 minutes After 5 minutes After 10 minutes*
Backlight OFF	Activates or deactivates the display turns off.	ON OFF*
	Determines when the display turns off. Tap the screen to end Backlight OFF mode.	After 30 seconds After 1 minute After 2 minutes After 5 minutes After 10 minutes
Quick wake up	Terminates Sleep mode and/or Backlight OFF . By placing the sample on the weighing pan, the Sleep mode and/or Backlight OFF will be terminated.	ON* OFF
Out of level notification	Activates or deactivates the function Out of level notification .	ON* OFF
Service due notification	Activates or deactivates the function Service due notification .	ON* OFF

* Factory setting

If **Sleep mode** and **Backlight OFF** have the same value, the screen saver briefly appears before the backlight switches off.

Advanced options

The following advanced options can be set:

Parameter	Description
Reset balance...	Resets the balance to factory settings.

Backup and restore balance settings...	Generates a backup of the current balance settings (excluding MinWeigh, service due notification and ISO-Log). To execute a backup, an external storage device (USB memory stick, FAT32) must be connected to the USB host (type A). Additionally, if an external storage device (USB memory stick, FAT32) is attached with a back-up file, it can be restored. We do not recommend to back-up/restore balance settings between approved and non-approved balance models.	
Software update...	Activates or deactivates the option to update the balance software. The balance software can be updated by a METTLER TOLEDO service technician only.	ON* OFF
Turn OFF communication...	Activates or deactivates communication from/to the balance via any interface except the touch display. If turn off, any device connected to as well as any service/function using any balance interface will not be available for usage anymore, e.g., Printer, Backup/Restore function. Network and Bluetooth-, Devices- and Publishing settings will not be available anymore.	



Note

By resetting the balance, any changes to the general settings and contextual settings that have been made along with any temporary collected data, e.g., paused applications or statistics will be lost.

5.2.6 User management

Navigation: > **General configuration and data** > **User management**

In the section **User management** rights for users and user groups can be defined. User management simplifies operations by customizing the user interface according the requirements of every user. Additionally, it helps in regulatory environments that actions and results on a device can be traced to the individual user. If user management is activated, access to the system is user-specific (user logon). The access to the system can be protected by a password. Create up to 20 users and assign them a previously defined access authorization (group). According the access authorization only the relevant information is shown to a specific user. After switching on the balance, the user must login with the password, depending on the settings. The user must logout to switch off.

- 1 Tap **User management**.
 - ➔ The screen **User management – General** appears.
- 2 Activate the **User management** and confirm with .
- 3 Tap to return to the **General configuration and data** screen.

The section **User management** is divided into the following sub-sections:

- **User management – General** defines general settings for all user profiles, see [General ▶ Page 48].
- **User management – Groups (4)** defines the settings for the user groups, see [Groups ▶ Page 48].
- **User management – User (1)** defines the settings for a single users, see [Users ▶ Page 50].

User password

The user password can be defined by the user. The length of the configurable user password is restricted to 16 digits.

What if you forget the password?

If you forget or lose the password, please ask the user with the administrator rights to provide you a new password. If also the administrator forgets or loses its password, please contact a METTLER TOLEDO representative. For more information please tap on the "?" icon on the **Login – User** screen of the administrator and generate an email with the relevant information by tapping on the on the right.

5.2.6.1 General

Navigation:  >  **General configuration** >  **User management** >  **User management – General**

In this section you can activate the **Auto Lock** function to block access to the work area for the currently logged in user after a certain time of inactivity or a specific balance condition.

- 1 Tap **User management**.
⇒ The screen **User management – General** appears.
- 2 Activate the **User management**.
- 3 Tap **Auto Lock**.
⇒ The screen **Auto Lock** appears.
- 4 Activate **Auto Lock**.
- 5 If necessary, change the conditions, when **Auto Lock** is activated (after a certain time, **On Sleep**, **On Backlight OFF**) and confirm with ✓.

The following options can be set:

Parameter	Description	Values
Auto Lock	Activates or deactivates the automatic lock access to work area. Defines the screen lock time.	ON OFF* After...* On Sleep On Backlight OFF

* Factory setting

5.2.6.2 Groups

Navigation:  >  **General configuration and data** >  **User management** >  **User management – Groups (4)**

In this section the access rights of the different user groups can be defined. All groups except the administrator can be changed or deleted. The maximal number of groups is 4. By customizing the available functions and settings for each user group, the complexity for the user can be reduced and the ease-of-use, productivity and process security can be increased.

The following 4 groups with different pre-defined access rights and group properties are available:

- **Administrators**
- **Lab managers**
- **Operators**
- **Quality managers**

Group properties

- 1 Tap **User management**.
⇒ The screen **User management – General** appears.
- 2 Tap .
⇒ The screen **User management – Groups (4)** appears.
- 3 Tap, e.g., **Operators**.
- 4 If necessary, edit the group parameter or change the group name and confirm with ✓.
- 5 Tap ✓ to return to the **User management – Groups (4)** screen.

Defining a group name

Parameter	Description	Values
Group name	Defines the name of the user group.	any (1 ... 16 chars)

Access rights – Activity specific

For the Administrator group, all available rights are activated by default and cannot be changed.

The following options can be set:

Parameter	Description	Values
Run applications (All)	Defines which of the available applications the group can access and execute. Values can be <input type="checkbox"/> (deactivated) or <input checked="" type="checkbox"/> (activated)*.	Weighing* Counting* Check weighing* Dynamic weighing* Percent weighing* Formulation* Totaling* Back-weighing* Differential weighing* Density* Factor weighing*
Run adjustments (All)	Activates or deactivates the adjustments. Enables the group to access and execute all available adjustments. Values can be <input type="checkbox"/> (deactivated) or <input checked="" type="checkbox"/> (activated)*.	ON* OFF
Run tests (All)	Activates or deactivates the tests. Enables the group to access and execute all available tests. Values can be <input type="checkbox"/> (deactivated) or <input checked="" type="checkbox"/> (activated)*.	ON* OFF
Configure applications	Configure the applications. Enables the group to access and edit the contextual settings of the application. The group has the right to access and execute. Values can be <input type="checkbox"/> (deactivated) or <input checked="" type="checkbox"/> (activated)*.	ON* OFF Main configuration* Reports* Statistics*
Configure adjustments	Configure the adjustments. Enables the group to access and change the settings of adjustments. Values can be <input type="checkbox"/> (deactivated) or <input checked="" type="checkbox"/> (activated)*.	ON* OFF
Configure tests	Configure the tests. Enables the group to access and change the settings of tests. Values can be <input type="checkbox"/> (deactivated) or <input checked="" type="checkbox"/> (activated)*.	ON* OFF

* Factory setting

Access rights – General configurations





The Administrator group have all rights activated by default.

Parameter	Description	Values
Quick settings/ Preferences	Activates or deactivates the access to the quick settings/ preferences. Values can be <input type="checkbox"/> (deactivated) or <input checked="" type="checkbox"/> (activated)*.	ON* OFF
Weighing options	Activates or deactivates the access to the weighing options. Values can be <input type="checkbox"/> (deactivated) or <input checked="" type="checkbox"/> (activated)*.	ON* OFF
Publishing	Activates or deactivates the access to the publishing settings. Values can be <input type="checkbox"/> (deactivated) or <input checked="" type="checkbox"/> (activated)*.	ON* OFF
Devices and services	Activates or deactivates the access to the device and service settings. Values can be <input type="checkbox"/> (deactivated) or <input checked="" type="checkbox"/> (activated)*.	ON* OFF
Network and Bluetooth	Activates or deactivates the access to the network and Bluetooth settings. Values can be <input type="checkbox"/> (deactivated) or <input checked="" type="checkbox"/> (activated)*.	ON* OFF
System settings Standard	Activates or deactivates the access to the standard system settings. Values can be <input type="checkbox"/> (deactivated) or <input checked="" type="checkbox"/> (activated)*.	ON* OFF
System settings Advanced	Activates or deactivates the access to advanced system settings. Values can be <input type="checkbox"/> (deactivated) or <input checked="" type="checkbox"/> (activated)*.	ON* OFF



User management	Activates or deactivates the access to the user management settings. Values can be <input type="checkbox"/> (deactivated) or <input checked="" type="checkbox"/> (activated)*.	ON* OFF
ISO-Log	Activates or deactivates the access to the ISO-Log. Values can be <input type="checkbox"/> (deactivated) or <input checked="" type="checkbox"/> (activated)*.	ON* OFF

* Factory setting

Creating new group

- 1 Tap **User management**.
 - ➔ The screen **User management – General** appears.
- 2 Tap .
 - ➔ The screen **User management – Groups (4)** appears.
- 3 Tap .
 - ➔ The screen **Group name** appears.
- 4 Enter the group name and confirm with .
 - ➔ The screen **Access rights – Activity specific** appears.
- 5 Select the group parameter (see table above) and confirm with .
- 6 Tap  to return to the **User management – Groups (4)** screen.

Editing a group





- 1 Tap **User management**.
 - ➔ The screen **User management – General** appears.
- 2 Tap .
 - ➔ The screen **User management – Groups (4)** appears.
- 3 Tap, e.g., **Operators**.
- 4 Edit the group parameter (see table above) and confirm with .
- 5 Tap  to return to the **User management – Groups (4)** screen.

Deleting a group



Note

The group **Administrators** as well as groups with assigned users cannot be deleted.



- 1 Tap **User management**.
 - ➔ The screen **User management – General** appears.
- 2 Tap .
 - ➔ The screen **User management – Groups (4)** appears.
- 3 Tap .
 - ➔ The screen **Remove groups** appears.
- 4 Tap, e.g., **Operators** and confirm with .
 - ➔ The screen **Confirm remove** appears.
- 5 Tap  to return to the **User management – Groups (4)** screen.
- 6 Tap  to confirm.
 - ➔ The screen **User management – Groups (4)** appears.

5.2.6.3 Users

Navigation:  >  **General configuration and data** >  **User management** >  **User management – User (1)**

In this section, you can create, edit or delete user accounts and set a user password. Password protection is deactivated by default.

Create a user

- 1 Tap **User management**.
 - ➔ The screen **User management – General** appears.
- 2 Tap .
- 3 Tap .
- 4 Enter a name and confirm with ✓.
 - ➔ The screen **Assigned group** appears.
- 5 Select a configuration of the access rights by tapping, e.g., **Operators** and confirm with ✓.
 - ➔ The screen **Password** appears.
- 6 If necessary, activate the password and confirm with ✓.
 - ➔ The screen **New password** appears.
- 7 Enter the password and confirm with ✓.
 - ➔ The screen **Confirm password** appears.
- 8 Enter the password again and confirm with ✓.
 - ➔ The screen **Password defined** appears.
- 9 Tap ✓ to confirm.
 - ➔ The new user is displayed in the user management.
- 10 Tap ✓ to return to the **User management – General** screen.

The following options can be set:

Parameter	Description	Values
User name	Displays or changes the name of the logged in user.	any (1 ... 16 chars)
Assigned group	Displays or changes the group assignment. All group names except the administrator can be changed.	Administrators* Lab managers* Operators* Quality managers*
Password	Activates or deactivates the password.	ON OFF*

* Factory setting

Editing a user



- 1 Tap **User management**.
 - ➔ The screen **User management – General** appears.
- 2 Tap .
- 3 Select the user you want to edit by tapping.
- 4 If necessary, change the assigned group, password or user name and confirm with ✓.
- 5 Tap ✓ to return to the **User management – User (1)** screen.

Deleting a user



Note

The user **Administrators** and the currently active user cannot be deleted.

- 1 Tap **User management**.
 - ➔ The screen **User management – General** appears.
- 2 Tap .
- 3 Tap .
- ➔ The screen **Remove users** appears.

- 4 Select the user you want to delete by tapping.
 - ➔ The screen **Confirm remove** appears.
- 5 Tap ✓ to return to the **User management – User (1)** screen.
 - ➔ The screen **User management – User (1)** appears.

Activate password

Activate the password for the administrator and/or user.

- 1 Tap **User management**.
 - ➔ The screen **User management – General** appears.
- 2 Tap .
 - ➔ The screen **User management – User (1)** appears.
- 3 Select, e.g., **Administrator** by tapping.
 - ➔ The screen **Administrator** appears.
- 4 Tap **Password**.
 - ➔ The screen **Password** appears.
- 5 Activate **Password** and confirm with ✓.
- 6 Enter the password and confirm with ✓.
 - ➔ The screen **Confirm password** appears.
- 7 Enter the password again and confirm with ✓.
 - ➔ The screen **Password defined** appears.
- 8 Tap ✓ to confirm.
- 9 Tap ✓ to return to the **User management – User (1)** screen.
 - ➔ The screen **User management – User (1)** appears.
- 10 Tap ✓ to return to the **User management – General** screen.

5.2.6.4 User login / lock / logout

Navigation:  >  **General configuration and data** >  **User management** >  **User management – User (1)**

If the user password is activated, the user must login with the defined password. To release the balance for a different user, the user needs to logout first. Please be aware that the data and results generated by a specific user are not saved after a logout.

5.2.6.4.1 Login



There are different starting points to login to your user account.

Another user is still active and the screen is not locked

- User management is activated.
 - Users are defined.
 - Application screen appears.
- 1 Press and hold  until the dialog screen appears.
 - ➔ The screen **Quit balance** appears.
 - 2 Tap **Log out "JOHN"** (logged in user).
 - ➔ The screen **Logout** appears.
 - 3 Tap ✓ to confirm.
 - ➔ The screen **Login – User (4)** appears.
 - 4 Select the user, e.g., **LEA** by tapping.
 - ➔ The application screen appears directly or after the password of the user LEA is entered. LEA is the logged in user.



Another user is still active and the screen is locked

- User management is activated.
 - The screen is locked (either manually by the user or automatic as **Auto Lock** is activated).
 - Users are defined.
 - Screen with logged in user appears.
- 1 Tap anywhere on the screen or the terminal bar to unlock.
 - ➔ The application screen appears.
 - ➔ If the currently logged in user is protected by a password, the **Password** screen appears.
 - 2 Tap .
 - ➔ The screen **Login – User (4)** appears.
 - ➔ If the currently logged in user is not protected by a password the application screen appears.
 - 3 Press and hold  until the dialog screen and follow the instructions as explained in the chapter logout later in this chapter.
 - ➔ The screen **Login – User (4)** appears.
 - 4 Select the user, e.g., **LEA** by tapping.
 - ➔ The application screen appears directly or after the password of the user LEA is entered. LEA is the logged in user.

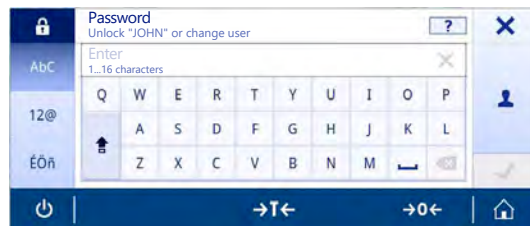
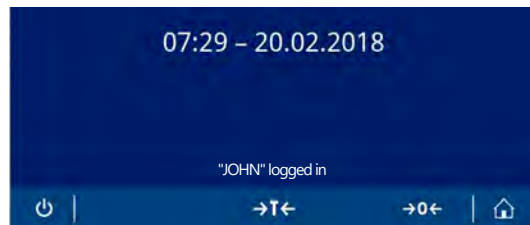

No user is active and the login screen appears

- User management is activated.
 - Users are defined.
 - Screen with **Login – User (4)** appears.
- Tap, e.g., **LEA**.
 - ➔ The application screen appears. LEA is the logged in user.



5.2.6.4.2 Lock

With the lock function the access to the work area of the current user is blocked. The lock function can be activated either automatically, see **Auto Lock** [General ▶ Page 48] for the configuration or can be activated manually anytime. Below the manual process is described.

- User is logged in.
 - Screen with the logged in user appears.
- 1 Press and hold  until the dialog screen appears.

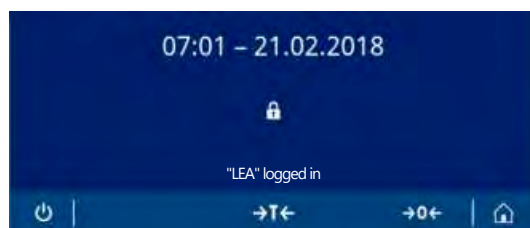

- ➔ The screen **Quit balance** appears.
- 2 Tap **Lock (Password OFF)**.
 - ➔ The screen with the logged in users appears.

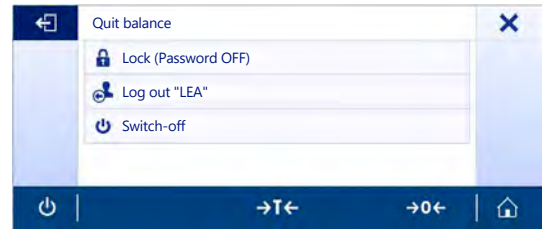

5.2.6.4.3 Logout

- User is logged in.
- 1 Press and hold until the dialog screen appears.
 - ➔ The screen **Quit balance** appears.
- 2 Tap, e.g., **Log out "LEA"** ("LEA" is the active logged in user).
 - ➔ The screen **Logout** appears.
- 3 Tap to confirm.
 - ➔ The screen **Login – User (4)** appears.

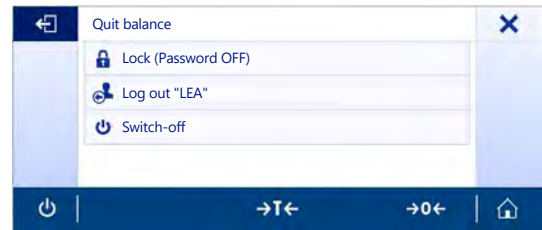

5.2.7 ISO-Log

Navigation: > **General configuration and data** > **ISO-Log**

In this section, detailed information about adjustments already performed, intensity of use and settings can be displayed. ISO-log can store up to 999 events until the oldest one is overwritten.

- 1 Tap **ISO-Log**.
 - ➔ The screen **ISO-Log** appears.
- 2 Tap, e.g., **ISO-Log – Adjustments**.
 - ➔ The screen **ISO-Log – Adjustments** with all results appears.
- 3 Tap to return to the configuration screen.
- 4 Tap to return to the application home screen.

The following options can be set:

Parameter	Description
ISO-Log – Adjustments	Displays detailed information about adjustments already performed.
ISO-Log – Balance	Displays detailed information about the balance history.
ISO-Log – Settings and status	Displays detailed information about setting changes.
ISO-Log – Activity fails	Displays detailed information about communication errors (maximum last 90 events).

6 Application Settings

Navigation:  >  **Activities - Weighing and other applications**

Each application can be defined manually via its application settings. Select the application and tap the application settings symbol in the upper left corner to define the application, e.g.,  in the application **Percent weighing**.

The application settings can only be changed if no measurement is in progress.

The available options may differ depending on the application. Most applications have the following options:

-  **Main configuration**
-  **Reports configuration**
-  **Statistics**

6.1 Main configuration

Navigation:  >  **Activities - Weighing and other applications** > 

In this section, the current application individually be defined individually. The available options may vary depending on the application.

More information about the available options can be found in the activities section.

6.2 Reports configuration

Navigation:  >  **Activities - Weighing and other applications** > 

In this section, the report content can be configured. By default only the weighing value and the weight unit is published. Any additional information can be configured by the user.

The available options are model and country-specific and may vary depending on the application. The report configuration is valid independently of the report type. As far as possible the same content is published on a XML, PDF, CSV or TXT file or when printed on the strip printer. However, each report type has certain limitations.

Identifications

Define if and how task- and sample identifications are used by the application.

The following options can be set:

Parameter	Description	Values
Identifications	Activates or deactivates the identifications.	ON OFF*
ID 1 ... ID 4	Activates or deactivates ID 1 ... ID 4 ID 4 = for sample identification.	ON OFF*
	Defines content and behavior of the single IDs. Activate Input prompt if you want to change the ID value for each result.	ID Label ID Value Autoincrement Input prompt

* Factory setting

Optional report data

Define additional information to be published in report printouts and report files.

The following options can be set:

Parameter	Description	Values
Title information	Activates or deactivates the title information.	ON OFF*
	Defines if the application title, data and time appears on the report.	Report title Date, time

Balance information	Activates or deactivates the balance information.	ON OFF*
	Defines which balance information appears on the report.	Balance type Balance identification Software version Serial number (SNR) FACT status Last adjustment
Task information	Activates or deactivates the task information.	ON OFF*
	Defines which task information and if the gauss chart appears on the report. The gauss chart is only generated if the statistic options is activated and 3 or more samples values are taken into consideration. The gauss chart is only available on the PDF report.	Application parameters MinWeigh parameters Gauss chart
Sample information	Activates or deactivates the sample information.	ON OFF*
	Defines which sample information appears on the report.	Gross/Tare weight Additional unit Leveling status Tolerance status
Footer	Activates or deactivates the footer.	ON OFF*
	Defines which information appears in the footer.	Date, time User name Signature line Empty lines

* Factory setting

Advanced options

The following options can be set:

Parameter	Description	Values
Print series	Activates or deactivates the print series.	ON OFF*

* Factory setting

This option allows you to print a series of weight values using the same header and footer, e.g., header, sample 1, sample 2, sample 3, footer. The series starts with the printout of the first value and can be terminated at any time.

This option is only available for **Weighing, Counting, Check weighing, Dynamic weighing, Percent weighing** and **Factor weighing** applications and works only when publishing on a strip printer or generating a TXT file.

6.2.1 Working with IDs

Identifications (IDs) contain descriptive text for measurements, enabling samples to be easily allocated to specific tasks or customers. This feature defines identifications in order to be able comment on measurements, such as company ID, batch ID or sample ID.

Identifications must be defined under the application settings in **Reports configuration**. Usage and definition of the ID differ depending on the application for which the ID is used.

Identification dialog screen

The Identification dialog screen may vary slightly depending on the application for which the ID is used. The dialog screen always consists of two parts:

- The table with the ID definitions on the upper part of the screen.
- The **Workflow handling options** on the lower part of the dialog screen.

6.2.2 Defining an ID

The maximum length of an ID is 16 characters.

- 1 Open an application, e. g., **Weighing**.
- 2 Tap the application settings symbol in the upper left corner.
- 3 Tap  **Reports configuration**.
- 4 Tap **Identifications**.
 - ➔ The screen **Identifications** appears.
- 5 Tap **ID 1**.
 - ➔ The input dialog **ID 1** appears. The input dialog is inactive.
- 6 Activate **ID 1** with the switch in the title bar.
 - ➔ The input dialog **ID 1** is activated.
- 7 Tap **ID Label**.
 - ➔ The screen **ID Label** appears.
- 8 Define **ID Label** and confirm with ✓.
- 9 Tap **ID Value** if required or keep it empty if the **ID Value** must be added later during the measurement.
 - ➔ The screen **ID Value** appears.
- 10 Define **ID Value** and confirm with ✓.
- 11 Activate **Autoincrement** and **Input prompt** if required and confirm with ✓.
- 12 If necessary, activate and define **ID 2** and **ID 3**. The procedure is the same as described under **ID 1**.
- 13 If necessary, activate and define **ID 4** for **Sample identification**. The procedure is the same as described under **ID 1**.
- 14 Tap ✓ to confirm.

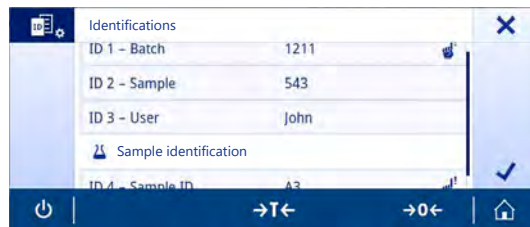

6.2.3 Workflow handling options

The workflow handling options differ depending on the application in which they are used. The following functions are available:

- **Autoincrement**
- **Input prompt**

Autoincrement

The function **Autoincrement** specifies that the last part of the ID is incremented with each use of that ID. There are two basic functions depending on how the ID is defined:

- If there is no counter in the ID, the system automatically adds a counter to the ID starting with 1 (e.g., the ID **Process 1** will be **Process 1** in the next use).
- If a counter is part of the ID, the system automatically increments the ID starting at that counter (e.g., the ID **Process 1** will be **Process 2** in the next use).
- The counter must be set at the end of the ID, otherwise the system doesn't recognize the number as a counter (e.g., in **567Apple** the system doesn't recognize **567** as a counter).
- If the ID has no counter and a maximum length of 16 characters, the last few characters will be overwritten by the counter.

Input prompt

The **Input prompt** function can be used for every ID. If **Input prompt** is activated, the ID will be prompted on the display before it is used. The user can decide whether to use the default value that has been defined with the ID or define an individual value. The value can either be defined with the keyboard on the touch screen, by reading in the information with a barcode reader or by attaching an external keyboard to the balance. For more information please refer to **Devices and services**.

6.3 Statistics

Navigation:  >  **Activities - Weighing and other applications** > .

The **Statistics** function generates statistics for a series of results. The **Statistics** function is not available for the applications **Totaling** and **Formulation**.

The **Automatic** setting is used to automatically transfer the result to the statistics. If using the **Manual** setting, the **+** key must be pressed to transfer the result.

If there are more than 3 values from a series in the statistics, the result is also displayed as a Gaussian curve.

If statistics are activated, the following options are available during the weighing process:

- Finish, publish and discard data
- Pause
- View result
- Discard data

Statistics configuration

The following options can be set:



Parameter	Description	Values
Acceptance range	Defines the acceptable deviation in relation to the average value.	1%...100% (30%*)
Accepting mode	Defines if a weight sample is added automatically to the result.	Automatic Manual*

* Factory setting

Stability criteria: Relationship between readability and deviation



Readability	Min. deviation
0.1 mg	0.1 g
0.001 g	1 g
0.01 g	1 g
0.1 g	1 g
1 g	5 g

Defining statistics

- 1 Open an application, e.g., **Weighing**.
- 2 Tap the main configuration symbol of the application, e.g., .
➔ The main configuration screen appears.
- 3 Tap .
➔ The screen **Statistics** appears.
- 4 Activate the **Statistics**.
- 5 Define the available options.
- 6 Tap  to confirm.

Discard value

If a weighing value was incorrect, it can be discarded from the result. Discard is only possible up to the last time the balance was tared.

- 1 Tap .
➔ The dialog screen **Confirm discard** appears. An overview with all values within the current weighing process is displayed.
- 2 Tap  to discard the last value from the result.
➔ The incorrect value has been deleted. The weighing process can be continued.

Terminate the application

- 1 Tap .

- ➔ A dialog screen appears.
- 2 Tap ✓ **Finish, publish and discard data.**
 - ➔ The results are published according to the publishing configurations and the data are deleted.
 - ➔ The application home screen appears.

Discard data

All results are deleted.

- 1 Tap ■.
 - ➔ A dialog screen appears.
- 2 Tap ✕ **Discard data.**
 - ➔ All data are deleted.
 - ➔ The application home screen appears.

View result

A Gauss curve is presented when 3 or more samples have been recorded.

- 1 Tap ■.
 - ➔ A dialog screen appears.
- 2 Tap 📄 **View result.**
 - ➔ The results are now displayed.
- 3 Tap 📈.
 - ➔ The Gauss curve is displayed.
- 4 Tap 📄 to publish the results according to the configurations.
- 5 Tap ⬅️ to return to the previous screen.

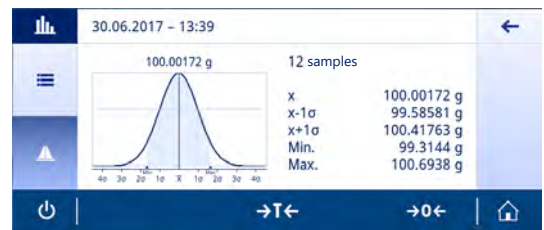

7 Activities

Navigation: 











The **Activities** section includes the following two sub-sections:

- **Activities - Weighing and other applications**
- **Activities - Adjustments and tests**

7.1 Activities - Weighing and other applications

Navigation:  >  **Activities - Weighing and other applications**

Activities - Weighing and other applications includes the following applications:

-  **Weighing**, see [Weighing ▶ Page 61] and [Performing a simple weighing ▶ Page 27]
-  **Counting**, see [Counting ▶ Page 62]
-  **Check weighing**, see [Check weighing ▶ Page 66]
-  **Dynamic weighing**, see [Dynamic weighing ▶ Page 69]
-  **Percent weighing**, see [Percent weighing ▶ Page 71]
-  **Formulation**, see [Formulation ▶ Page 72]
-  **Totaling**, see [Totaling ▶ Page 75]
-  **Back-weighing**, see [Back-weighing ▶ Page 78]
-  **Differential weighing**, see [Differential weighing ▶ Page 81]
-  **Density**, see [Density ▶ Page 92]
-  **Factor weighing**, see [Factor weighing ▶ Page 94]

7.1.1 Weighing

Navigation:  **Activities** >  **Activities - Weighing and other applications** >  **Weighing**

The **Weighing** application allows the user to perform simple weighing operations.

For more information about the basic weighing functions, see [Performing a simple weighing ▶ Page 27].

The statistics function can be activated; information on this topic can be found in [Statistics ▶ Page 58].



Weighing – Main configuration

The following options can be set:

Parameter	Description	Values
Main unit	Sets the main unit of the weighing process. The available units are model- and country-specific.	g* kg mg µg ct N lb oz ozt GN dwt mom msg tlh tils tft tcl tola baht lb:oz
Readability	Defines the readability (d) of the weighing process. The available readabilities are model-specific.	1d - 0.0001 g* 2d - 0.0002 g 5d - 0.0005 g 10d - 0.001 g 100d - 0.01 g 1000d - 0.1 g
Secondary information	Activates or deactivates the secondary information displayed on screen. Additional unit* Selects the secondary information displayed on screen. The available units are model- and country-specific. Current tare Current tare weight.	ON OFF*
MinWeigh	Activates or deactivates the MinWeigh function.	ON OFF*
Target and tolerances	Defines the target weight and tolerances. Target weight Predefines a target weight. The value can be selected manually or by weighing. Upper tolerance Defines the upper tolerance. Lower tolerance Defines the lower tolerance. If the value for Target weight , Upper tolerance or Lower tolerance has been defined, the option title Target and tolerances will be replaced by the defined values.	ON OFF* Numerical value (depending on the balance type)

* Factory setting

Setup the weighing application

- 1 Tap .
 - ➔ The screen **Weighing – Main configuration** appears.
- 2 Tap e.g. **Main unit**.
 - ➔ The screen **Main unit** appears.
- 3 Select the desired unit by tapping it.
- 4 Tap  to confirm.
 - ➔ The screen **Weighing – Main configuration** appears.
- 5 Tap  to confirm the configuration.

7.1.2 Counting

Navigation:  **Activities** >  **Activities - Weighing and other applications** >  **Counting**

The **Counting** application determines a specific number of pieces based on a predetermined reference piece weight.

There are two counting modes available: **Advanced** and **Standard**. With the additional features of **Advanced** mode, the entire process is more comfortable and more secure due to an automatic workflow. The mode can be changed in the section **Counting – Main configuration**. Default mode: **Advanced**.

The statistics function can be activated; information on this topic can be found in [Statistics ▶ Page 58].

Legal-for-trade

A fixed minimum reference piece number of 10 and inactive reference weight options are predetermined for approved balances for selected countries.

7.1.2.1 Counting - Main configuration

The following options can be set:

Parameter	Description	Values
Counting mode	Select the Counting mode .	Advanced* Standard
Reference piece weight	Sets the number and weight of the reference piece(s).	1 ... 999 (10*)
Secondary information	Activates or deactivates the secondary information displayed on screen. Additional unit* Selects the secondary information displayed on screen. The available units are model- and country-specific. Current tare Current tare weight.	ON* OFF
Target and tolerances	Defines the target weight and tolerances. Target weight Predefines a target weight. The value can be selected manually or by weighing. Upper tolerance Defines the upper tolerance. Lower tolerance Defines the lower tolerance. If the value for Target weight , Upper tolerance or Lower tolerance has been defined, the option title Target and tolerances will be replaced by the defined values.	ON OFF* Numerical value (depending on the balance type)

* Factory setting

Advanced mode options

The following options can be set:

Parameter	Description	Values
Reference mode	Selects the Reference mode . Automatic The next stable weight is automatically accepted as a reference weight according to the defined piece number. Manual The reference can be defined manually.	Automatic* Manual

Auto clear reference	Activates or deactivates the Auto clear reference . The current value of the option Reference piece weight will be automatically deleted after zeroing or removing all loaded weights from the weighing pan.	ON OFF*
Reference optimization	Activates or deactivates the Reference optimization . The current reference will be continuously optimized during operation by accepting additional pieces automatically or manually.	ON OFF*
Reference check	Activates or deactivates the Reference check .	ON OFF*
Accuracy information	Activates or deactivates the Accuracy information . Counting accuracy can be shown in percent (default mode) or piece(s).	ON OFF*





* Factory setting

7.1.2.2 Defining reference piece weight in standard mode

To define the **Reference piece weight**, the **Reference piece number** and **Reference weight** must be successively defined. The system will automatically navigate from one option to the other.

Defining reference piece number



The reference piece number must be a number between 1 and 999.

- 1 Tap .
 - ➔ The screen **Counting – Main configuration** appears.
- 2 Tap **Counting mode**.
 - ➔ The screen **Counting mode** appears.
- 3 Activate **Standard**.
- 4 Tap  to confirm.
- 5 Tap **Reference piece weight**.
 - ➔ The dialog screen **Reference piece number** appears.
- 6 Tap  to delete the value.
- 7 Enter the number of reference pieces.
- 8 Tap  to confirm.
 - ➔ The dialog screen **Reference weight** appears.

Defining the reference weight

There are two ways to define the reference weight. The reference weight can be defined manually by entering the value or weighing the reference weight.

Defining reference weight manually

- 1 Tap  to delete the value.
- 2 Enter the new reference weight.
- 3 Tap  to confirm.
 - ➔ The reference piece weight has been defined.
- 4 Tap  to confirm.

Defining the reference weight by weighing

- 1 Tap .
 - ➔ A dialog screen appears.
- 2 Place the reference weight on the weighing pan.
- 3 Tap ✓ to confirm.
 - ➔ The screen **Reference weight** appears.
- 4 Tap ✓ to confirm.
 - ➔ The screen **Counting – Main configuration** appears.
- 5 Tap ✓ to confirm the configuration.

7.1.2.3 Defining reference piece weight in advanced mode

To define the **Reference piece weight**, the **Reference piece number** and **Reference weight** can be defined directly via the shortcuts.

Defining the reference piece number

The reference piece number must be a number between 1 and 999.

- Counting mode **Advanced** is activated.

- 1 Tap **1 piece** in the work title bar.
 - ➔ A dialog screen appears.
- 2 Tap **Piece number**.
- 3 Tap ✕ to delete the value.
- 4 Enter the number of reference pieces.
- 5 Tap ✓ to confirm.
 - ➔ The defined value for the option **Reference piece number** appears in the work title bar.

Defining the reference piece weight manually

- 1 Tap **Piece weight** in the work title bar.
 - ➔ The screen **Reference piece weight** appears.
- 2 Tap ✕ to delete the value.
- 3 Enter the new value.
- 4 Tap ✓ to confirm.
 - ➔ The defined value for the option **Reference piece weight** appears in the work title bar.

Defining reference piece weight by weighing

If no reference weight has been defined yet, the work title bar shows **Piece weight Not defined**.

- 1 Place the reference sample weight on the weighing pan.
- 2 Depending on whether the option **Reference mode** is set to **Automatic (Default)** or **Manual**, the value will be automatically accepted or must be confirmed.
 - ➔ The balance returns to the application main screen and shows the defined value for the option **Reference piece weight** in the work title bar.

Once the reference weight has been defined in **Advanced** mode, it appears on the right side of the work title bar. The reference weight can be changed in **Main configuration** under **Reference piece weight** or using the shortcut on the left side of the work title bar.

Counting with reference weight check

The reference weight check ensures that the reference weight is high enough for the resulting counting accuracy to fit the customer process tolerance. Activate a reference weight check and define the process tolerance in percent. The percentage factor range is 0.01 - 30.00%. The higher the factor, the smaller the required minimum reference weight. Factory setting: 2%. The minimum reference weight is equal to d / factor .

Example

$d = 0.1 \text{ g}$

Factor = 20%

Minimum reference weight = $0.1 \text{ g} / 20\% = 0.5 \text{ g}$

If the reference calculation is activated manually or automatically, the minimum reference weight is checked to ensure the desired accuracy. If it is not sufficient, the user is prompted to add the number of additional parts needed. The number of additional parts needed is reduced to zero, after which the user adds additional parts. At zero, the reference calculation is activated automatically. If too many parts are added, the user is prompted to remove the number of parts until zero is reached.

7.1.3 Check weighing

Navigation:  **Activities** >  **Activities - Weighing and other applications** >  **Check weighing**

The **Check weighing** application allows the user to check the deviation of a sample weight within a tolerance limit against a reference target weight. The target weight can be determined manually or by weighing; the tolerance limit must be defined manually.

The statistics function can be activated; information on this topic can be found in [Statistics ▶ Page 58].

7.1.3.1 Check weighing - Main configurations

Legal-for-trade

For approved balances, this menu item has fixed settings and cannot be changed.

The following options can be set:

Parameter	Description	Values
Target and tolerances	<p>Defines the target weight and tolerances.</p> <p>Target weight Predefines a target weight. The value can be selected manually or by weighing.</p> <p>Upper tolerance Defines the upper tolerance.</p> <p>Lower tolerance Defines the lower tolerance.</p> <p>If the value for Target weight, Upper tolerance or Lower tolerance has been defined, the option title Target and tolerances will be replaced by the defined values.</p>	<p>Target weight Upper tolerance Lower tolerance Numerical value (depending on the balance type)</p>
Tolerance threshold	Defines the tolerance threshold. Values below the defined threshold are not checked.	1%...100% (1%*)
Within tolerance beeps	<p>Activates or deactivates the acoustic signal.</p> <p>Gives an acoustic signal when the result is within tolerance.</p>	ON OFF*
Main unit	<p>Sets the main unit of the weighing process.</p> <p>The available units are model- and country-specific.</p>	<p>g* kg mg µg ct N lb oz ozf GN dwt mom msg tih tils ttf tcl tola baht lb:oz</p>
Readability	<p>Defines the readability (d) of the weighing process.</p> <p>The available readabilities are model-specific.</p>	<p>1d - 0.0001 g* 2d - 0.0002 g 5d - 0.0005 g 10d - 0.001 g 100d - 0.01 g 1000d - 0.1 g</p>
Secondary information	<p>Activates or deactivates the secondary information displayed on screen.</p> <p>Additional unit* Selects the secondary information displayed on screen. The available units are model- and country-specific.</p> <p>Current tare Current tare weight.</p>	ON OFF*





* Factory setting

7.1.3.2 Before performing check weighing operation





Before performing a check weighing operation, the following options can be set:

- **Target weight**
- **Upper tolerance limit**
- **Lower tolerance limit**
- **Tolerance threshold**







Defining the target weight manually by entering the nominal weight

- 1 Tap .
➔ The screen **Check weighing - Main configuration** appears.
- 2 Tap **Target and tolerances**.
➔ The dialog screen **Target weight in g** appears.
- 3 Tap  to delete the value.
- 4 Enter the value of the target weight.
- 5 Tap  to confirm.
➔ The screen **Check weighing - Main configuration** appears.
- 6 Tap  to confirm, and return to the application screen.

Defining the target weight by weighing



- 1 Tap .
➔ The screen **Check weighing - Main configuration** appears.
- 2 Tap **Target and tolerances**.
➔ The dialog screen **Target weight in g** appears.
- 3 Tap .
➔ The dialog screen **Target weight in g** appears.
- 4 Place the reference weight on the weighing pan.
- 5 Tap  to confirm.
➔ The dialog screen **Target weight in g** appears.
- 6 Tap  to confirm.
➔ The screen **Check weighing - Main configuration** appears.
- 7 Tap  to confirm, and return to the application screen.

Defining the lower and upper limits manually by entering a percentage value or weight

- 1 Tap .
➔ The screen **Check weighing - Main configuration** appears.
- 2 Tap **Target and tolerances**.
➔ The dialog screen **Target weight in g** appears.
- 3 Tap  **Upper tolerance limit** or tap  **Lower tolerance limit**.
➔ The dialog screen **Upper tolerance in g** or **Lower tolerance in g** appears.
- 4 Activate the option using the switch at the upper right.
- 5 Tap  to delete the value.
- 6 Tap  to delete the value.
- 7 Enter the tolerance limit.
- 8 Tap  to confirm.
➔ The screen **Check weighing - Main configuration** appears.
- 9 Tap  to confirm, and return to the application screen.

Defining tolerance threshold

With the option **Tolerance threshold** a value limit can be set using the **Tolerance threshold** option. If the value of the check weight is below the defined threshold, it will not be checked.

- 1 Tap .
 - ➔ The screen **Check weighing - Main configuration** appears.
 - 2 Tap **Tolerance threshold**.
 - ➔ The dialog screen **Tolerance threshold in %** appears.
 - 3 Activate the option using the switch at the upper right.
 - 4 Tap **x** to delete the value.
 - 5 Enter the value for the **Tolerance threshold**.
 - 6 Tap  to confirm.
 - ➔ The screen **Check weighing - Main configuration** appears.
 - 7 Tap  to confirm, and return to the application screen.
- The **Tolerance threshold** option always refers to the lower tolerance limit.

7.1.3.3 Performing check weighing

After defining the target weight and tolerance limits, the **Check weighing** application can be performed. The color weighing-in aid bar at the top bar indicates whether the weight sample is within the defined tolerances.

Example: the defined target weight is 100.0000 g and the tolerance limit is $\pm 2.5\%$. The sample weight is 97.0000 g.

- Place the sample weight on the weighing pan.
 - ➔ The weight is stable and the instability symbol  disappears.
 - ➔ The value is out of tolerance, and the weighing-in aid bar and weighing value field are red.

Example: the defined target weight is still 100.0000 g and the tolerance limit is $\pm 2.5\%$. The sample weight is 99.0000 g.

- Place the sample weight on the weighing pan.
 - ➔ The weight is stable and the instability symbol  disappears.
 - ➔ The value is within the tolerance limit, and the weighing-in aid bar and weighing value field are green.

If the weight is below a defined tolerance threshold, the background color of the screen does not change.

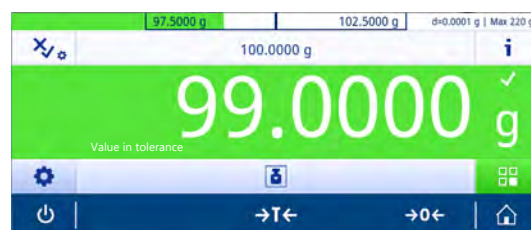
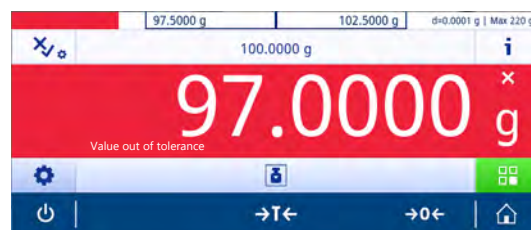

7.1.4 Dynamic weighing

Navigation: **Activities** > **Activities - Weighing and other applications** > **Dynamic weighing**

The **Dynamic weighing** application determines the weights of unstable samples or when the weighing process is being executed under unstable ambient conditions. The balance calculates the weight as an average of a number of weighing operations over a defined time.

The statistics function can be activated; information on this topic can be found in [Statistics ▶ Page 58].

The displayed measuring time on the application home screen can be used as shortcut to define the measuring time.

Dynamic weighing – Main configuration

The following options can be set:

Parameter	Description	Values
Measuring time	Defines the measuring time in seconds.	3...120 (3 seconds*)
Start mode	Defines the Start mode .	Automatic* Start measuring on relative stability Automatic Start measuring after 3 seconds Manual Start measuring at will
Main unit	Sets the main unit of the weighing process. The available units are model- and country-specific.	g* kg mg µg ct N lb oz ozt GN dwt mom msg tlh tls tff tcl tola baht lb:oz
Readability	Defines the readability (d) of the weighing process. The available readabilities are model-specific.	1d - 0.0001 g* 2d - 0.0002 g 5d - 0.0005 g 10d - 0.001 g 100d - 0.01 g 1000d - 0.1 g
Secondary information	Activates or deactivates the secondary information displayed on screen. Additional unit* Selects the secondary information displayed on screen. The available units are model- and country-specific. Current tare Current tare weight.	ON OFF*

* Factory setting

Defining measuring time

- 1 Tap .
 - ➔ The screen **Dynamic weighing – Main configuration** appears.
- 2 Tap **Measuring time**.
 - ➔ The dialog screen **Measuring time in seconds** appears.
- 3 Tap to delete the value.
- 4 Enter a value between 3 and 120 seconds.
- 5 Tap to confirm.
 - ➔ The screen **Dynamic weighing – Main configuration** appears.
- 6 Tap to confirm.

Defining start mode

- 1 Tap .

- 2 Tap **Start mode**.
- 3 Select **Automatic* Start measuring on relative stability, Automatic Start measuring after 3 seconds** or **Manual**.
- 4 Tap ✓ to confirm.
- 5 Tap ✓ to return to the application screen.

Performing dynamic weighing

When the measuring time and the start mode have been defined, the dynamic weighing process can be started. The weighing process will automatically be aborted when an overload or underload is detected.

- 1 Press →**0**← to zero the balance.
- 2 If using a container: place container on the weighing pan and press →**T**← to tare the balance or use the "Weighing option" menu [Auto tare ▶ Page 35].
- 3 Place sample weight.
 - ➔ If **Start mode** is set to **Automatic Start measuring on relative stability**, the weighing process starts automatically with relative stability.
 - ➔ If **Start mode** is set to **Automatic Start measuring after 3 seconds**, the weighing process starts automatically after 3 seconds.
 - ➔ If **Start mode** is set to **Manual**, tap ▶ to start the weighing process.
 - ➔ The weighing process starts. The defined measuring time in the work title bar is counting down.
- ➔ The result is displayed in a blue weighing value field.

7.1.5 Percent weighing

Navigation:  **Activities** >  **Activities - Weighing and other applications** > **% Percent weighing**

Percent weighing allows a sample weight to be checked as a percentage of a reference target weight.

The statistics function can be activated; information on this topic can be found in [Statistics ▶ Page 58].

Percent weighing – Main configuration

The following options can be set:





Parameter	Description	Values
Reference weight	Defines the reference weight manually or by weighing.	Available range is model-specific.
Secondary information	Activates or deactivates the secondary information displayed on screen. Additional unit* Selects the secondary information displayed on screen. The available units are model- and country-specific. Current tare Current tare weight.	ON* OFF

* Factory setting





Defining the reference weight

There are two ways to define the reference weight. The reference weight can be defined manually by entering the value or weighing the reference weight.

Defining the reference weight by weighing

- 1 Tap .
 - ➔ The screen **Percent weighing – Main configuration** appears.
- 2 Tap **Reference weight**.
 - ➔ The screen **Reference weight** appears.
- 3 Tap .
- 4 Press **→0←** to zero the balance.
- 5 Place the reference weight on the weighing pan.
- 6 Tap  to confirm.
 - ➔ The screen **Reference weight** appears.
- 7 Tap  to confirm.
- 8 Tap  to return to the application screen.

Defining the reference weight manually

- 1 Tap .
 - ➔ The screen **Percent weighing – Main configuration** appears.
- 2 Tap **Reference weight**.
 - ➔ The screen **Reference weight** appears.
- 3 Tap  to delete the value.
- 4 Enter the value of the reference weight and confirm with .
- 5 Tap  to return to the application screen.

7.1.6 Formulation

Navigation:  **Activities** >  **Activities - Weighing and other applications** >  **Formulation**

The **Formulation** application allows the user to:

- Weigh-in (add and store) up to 999 individual component weights without tare container and display the total.
- Tare/pre-tare and store up to 799 container weights and display the total.
- If tare containers need to be stored, the maximum number of permitted tares is 200.
- Fill up the sum of all component net weight values by adding a further component to a higher value.

Formulation – Main configuration

The following options can be set:

Parameter	Description	Values
Main unit	Sets the main unit of the weighing process. The available units are model- and country-specific.	g* kg mg µg ct N lb oz ozt GN dwt mom msg tih tils tlt tcl tola baht lb:oz
Readability	Defines the readability (d) of the weighing process. The available readabilities are model-specific.	1d - 0.0001 g* 2d - 0.0002 g 5d - 0.0005 g 10d - 0.001 g 100d - 0.01 g 1000d - 0.1 g



* Factory setting

Performing formulation

- 1 Press **→0←** to zero the balance.
- 2 If using a container: place container on the weighing pan and press **→T←** to tare the balance.
 - ➔ The status information field displays **Net**.
- 3 Place the first component weight.
 - ➔ The weighing value field displays the value of the first component weight.
- 4 Tap **+** to add the first component weight.
- 5 Place the second component weight.
 - ➔ The weighing value field displays the value of the second component weight.
- 6 Tap **+** to add the second component weight.
- 7 Continue adding components until all components are weighed.

Defining fill up function

Fill up sample allows an additional component weight to be added to the total weight of all components in order to reach a desired target weight.



- The weighing value field displays the total net weight.
- 1 Tap .
 - ➔ A dialog screen appears.
 - 2 Place the fill up sample.
 - ➔ The weighing value field displays the total weight.
 - 3 Tap  to confirm.
 - 4 Tap  to exit the application or to view the result.

The following options are available during the weighing process:



- Finish, publish and discard data
- Pause
- View result
- Discard data

Discard value



If a weighing value was incorrect, it can be discarded from the result. Discard is only possible up to the last time the balance was tared.

- 1 Tap .
 - ➔ The dialog screen **Confirm discard** appears. An overview with all values within the current weighing process is displayed.
- 2 Tap  to discard the last value from the result.
 - ➔ The incorrect value has been deleted. The weighing process can be continued.

Terminate the application

- 1 Tap .
 - ➔ A dialog screen appears.
- 2 Tap  **Finish, publish and discard data**.
 - ➔ The results are published according to the publishing configurations and the data are deleted.
 - ➔ The application home screen appears.

Pause the application





- 1 Tap .
 - ➔ A dialog screen appears.
- 2 Tap  **Pause**.
 - ➔ The application is paused and another application can be used in the meantime.
 - ➔ The application home screen appears.
- 3 Open the application again.
- 4 Tap .
 - ➔ The process can be continued.

View result

There are three different options for presenting the results. They can be chosen by pressing one of the three tabs on the left side of the screen:

- Text result
- Ring chart
- Bar chart

Only the text result can be printed.

- 1 Tap .
➔ A dialog screen appears.
- 2 Tap  **View result**.
➔ The results are now displayed.
- 3 Tap , to publish the results according to the configurations.
- 4 Tap .
➔ The results are presented in a ring chart, including the percentage ratio of the different samples.
- 5 Tap .





➔ The results are presented in a bar chart.

- 6 Tap  to return to the previous screen.



Discard data

All results are deleted.

- 1 Tap .
➔ A dialog screen appears.
- 2 Tap  **Discard data**.
➔ All data are deleted.
➔ The application home screen appears.

7.1.7 Totaling

Navigation:  **Activities** >  **Activities - Weighing and other applications** >  **Totaling**

The **Totaling** application allows the user to weigh different samples, add their weight values and totalize them.

The application allows the user to:

- Weigh-in (add and store) up to 999 individual component weights without tare container and display the total.

Totaling – Main configuration

The following options can be set:

Parameter	Description	Values
Accepting mode	Defines if a weight sample is added automatically to the result.	Automatic Manual*
Main unit	Sets the main unit of the weighing process. The available units are model- and country-specific.	g* kg mg µg ct N lb oz ozt GN dwt mom msg tth tls tft tcl tola baht lb:oz
Readability	Defines the readability (d) of the weighing process. The available readabilities are model-specific.	1d - 0.0001 g* 2d - 0.0002 g 5d - 0.0005 g 10d - 0.001 g 100d - 0.01 g 1000d - 0.1 g

* Factory setting

Stability criteria: Relationship between readability and deviation

Readability	Min. deviation
0.1 mg	0.1 g
0.001 g	1 g
0.01 g	1 g
0.1 g	1 g
1 g	5 g

Performing totaling

- 1 Press **→0←** to zero the balance.
- 2 If using a container, place container on the weighing pan and press **→T←** to tare the balance.
- 3 Place the first sample on the weighing pan.
- 4 Wait until the instability symbol **○** disappears.
 - ➔ When the balance is stable, the weighing value becomes dark blue.
- 5 Tap **+** to accept the weight and start the procedure.
- 6 Place the next sample.
- 7 Tap **+** to accept the second sample weight.
 - ➔ The work title bar shows the number of samples (2 samples) and the total weight of the samples, e.g., $\Sigma = 30.0000$ g.

The following options are available during the weighing process:

- Finish, publish and discard data
- Pause
- View result
- Discard data

Discard value

If a weighing value was incorrect, it can be discarded from the result. Discard is only possible up to the last time the balance was tared.

- 1 Tap **—**.
 - ➔ The dialog screen **Confirm discard** appears. An overview with all values within the current weighing process is displayed.
- 2 Tap **✓** to discard the last value from the result.
 - ➔ The incorrect value has been deleted. The weighing process can be continued.

Terminate the application

- 1 Tap **■**.
 - ➔ A dialog screen appears.
- 2 Tap **✓ Finish, publish and discard data**.
 - ➔ The results are published according to the publishing configurations and the data are deleted.
 - ➔ The application home screen appears.

Pause the application





- 1 Tap **■**.
 - ➔ A dialog screen appears.
- 2 Tap **|| Pause**.
 - ➔ The application is paused and another application can be used in the meantime.
 - ➔ The application home screen appears.
- 3 Open the application again.
- 4 Tap **▶**.
 - ➔ The process can be continued.

View result

There are three different options for presenting the results. They can be chosen by pressing one of the three tabs on the left side of the screen:

- Text result
- Ring chart
- Bar chart

Only the text result can be printed.

- 1 Tap .
 - ➔ A dialog screen appears.
- 2 Tap  **View result**.
 - ➔ The results are now displayed.
- 3 Tap  to publish the results according to the configurations.
- 4 Tap .
 - ➔ The results are presented in a ring chart, including the percentage ratio of the different samples.
- 5 Tap .





➔ The results are presented in a bar chart.

- 6 Tap  to return to the previous screen.



Discard data

All results are deleted.

- 1 Tap .
 - ➔ A dialog screen appears.
- 2 Tap  **Discard data**.
 - ➔ All data are deleted.
 - ➔ The application home screen appears.

7.1.8 Back-weighing

Navigation:  **Activities** >  **Activities - Weighing and other applications** >  **Back-weighing**

The balance displays and prints the automatically calculated difference of 2 measured weights. Automatic (default) and manual modes are possible. The use of a tare container can be activated (default) or deactivated. As result, the tare, initial weight, final weight and difference can be displayed and printed. The difference can be displayed and printed as absolute values (in main units), percentage (%), percentage (Abs. %), Atro AM, or Atro AD.

The statistics function can be activated; information on this topic can be found in [Statistics ▶ Page 58].

If there are no function statistics, the following options are available during the weighing process:

- Finish, publish and discard data
- Pause
- View intermediate result
- Discard data

Back-weighing – Main configuration

The following options can be set:





Parameter	Description	Values
Accepting mode	Defines if a weight sample is added automatically to the result. The next stable weight of at least 10 * readability is accepted following minimal deviation; see relationship between readability and deviation in the table below.	Automatic* Manual
Use tare container	Activates or deactivates the use of a tare vessel.	ON* OFF
Result value as...	Selects the result view for the calculated difference. Percentage (%) = Reports the difference between back-weighing and initial weighing as a percentage of the initial weight. Absolute percentage (Abs. %) = Reports back-weighing as a percentage of the initial weight. Moisture content (Atro AM) = Reports the moisture content of the sample as a percentage of the dry weight. Dry content (Atro AD) = Reports the wet weight of the sample as a percentage of the dry weight.	Weight (Default)* Percentage (%) Absolute percentage (Abs. %) Moisture content (Atro AM) Dry content (Atro AD)
Result decimals	Defines the number of decimal places of the percentage (option only available if % result is activated).	1 2 3* 4 5
Show difference...	Displays the calculated difference in work area and result view. Signed = Displays the value via algebraic sign. Unsigned (Default) = Displays the absolute value.	Signed Unsigned (Default)*
Main unit	Sets the main unit of the weighing process. The available units are model- and country-specific.	g* kg mg µg ct N lb oz ozt GN dwt mom msg flh fls flt tcl tola baht lb:oz
Readability	Defines the readability (d) of the weighing process. The available readabilities are model-specific.	1d - 0.0001 g* 2d - 0.0002 g 5d - 0.0005 g 10d - 0.001 g 100d - 0.01 g 1000d - 0.1 g

* Factory setting

Stability criteria: Relationship between readability and deviation

Readability	Min. deviation
0.1 mg	0.1 g
0.001 g	1 g
0.01 g	1 g
0.1 g	1 g
1 g	5 g

Setting up the back-weighing application

- 1 Tap .
➔ The screen **Back-weighing – Main configuration** appears.
- 2 Tap **Accepting mode**.
➔ The screen **Accepting mode** appears.
- 3 Select **Automatic (Default)** or **Manual** and confirm with .
- 4 Activate the option **Use tare container** if required.
- 5 Tap **Result value as...**
➔ The screen **Result value as...** appears.
- 6 Select the values for the result view, e.g., **Percentage (%)** and the print-out.
- 7 Tap  to confirm.
- 8 Tap **Result decimals** after percent value.
➔ The screen **Result decimals** appears.
- 9 Select the number of decimals for the difference in % and confirm with .
- 10 Tap  to return to the application screen.

Performing back-weighing with automatic accept mode and using a tare container

- **Use tare container** is activated.
 - **Accepting mode Automatic** is selected.
- 1 Place a container on the weighing pan.
➔ The tare weight appears in the work title bar.
 - 2 Place the initial sample in the container.
➔ The initial weight appears in the value bar.
 - 3 Remove the container with the sample.
 - 4 Place the container with the treated sample on the weighing pan.
➔ The final weight appears in the value bar.
 - 5 Remove the container with the sample.
➔ The back-weighing result will be displayed and can be published according to the publishing configurations.
 - 6 Tap  to return to the application screen.

Performing back-weighing with manual accept mode without using a tare container

- **Use tare container** is deactivated.
- **Accepting mode Manual** is selected.
- 1 Place the initial sample on the weighing pan.
 - ➔ The initial weight appears in the value bar.
- 2 Tap ✓ to confirm.
- 3 Remove the sample to continue.
- 4 Place the treated sample on the weighing pan.
 - ➔ The final weight appears in the value bar.
- 5 Tap ✓ to confirm.
- 6 Push checkmark to access the result report.
 - ➔ The back-weighing result will be displayed and can be published according to the publishing configurations.
- 7 Tap ✓ to return to the application screen.

7.1.9 Differential weighing

Navigation:  **Activities** >  **Activities - Weighing and other applications** >  **Differential weighing**

For differential weighing, one or several samples are checked for weight variations. The first step consists of determining the initial weight of the sample (initial weighing). Certain sample components are subsequently removed or added. Processes, e.g., drying, filtering, evaporation and coating, are also possible. After processing, the sample is weighed again (back-weighing). The balance subsequently determines the difference between the two values.

The principle function of the differential weighing application is very similar to the one of back-weighing. However, back-weighing is designed for a very basic work flow with one sample only and very few configuration options. The differential weighing application offers much more flexibility, with up to 200 samples and different workflow options, but it is also more complex to configure and use.

The statistics function can be activated; information on this topic can be found in [Statistics ▶ Page 58].

If there are no function statistics, the following options are available during the weighing process:

- Finish, publish and discard data
- Pause
- View intermediate result
- Discard data

Differential weighing – Main configuration

The following options can be set:

Parameter	Description	Values
Number of samples	Defines the numbers of samples. After all initial weighings are completed and when all weighing results for all samples are completed the user has the possibility to add more samples to the workflow.	1...200 (10*)
Back-weighings	Defines the number of Back-weighings per sample . The user has the possibility to add more back-weighings individually per sample once this is necessary during workflow by tapping on the + icon.	1* 2 3
Weighing sequence	Defines the workflow for weighing sequences. Initial weighings first (Default) = perform the initial weighing operation for all samples first. When complete, perform all final weighing operations and difference calculations (as many series as final weighings per defined sample). Sample by sample = perform the initial weighing operation with all defined final weighing operations and difference calculations, one sample after the other (from sample 1 to sample "n", according to sample list).	Initial weighings first (Default)* Sample by sample
Accepting mode	Defines if a weight sample is added automatically to the result. The next stable weight of at least 10 * readability is accepted following minimal deviation; see relationship between readability and deviation in the table below.	Automatic* Manual
Use tare container	Activates or deactivates the use of a tare vessel.	ON* OFF
Spill correction	Activates or deactivates the spill correction.	ON OFF*

Result value as...	Selects the result view for the calculated difference. Percentage (%) = Reports the difference between back-weighing and initial weighing as a percentage of the initial weight. Absolute percentage (Abs. %) = Reports back-weighing as a percentage of the initial weight. Moisture content (Atro AM) = Reports the moisture content of the sample as a percentage of the dry weight. Dry content (Atro AD) = Reports the wet weight of the sample as a percentage of the dry weight.	Weight (Default)* Percentage (%) Absolute percentage (Abs. %) Moisture content (Atro AM) Dry content (Atro AD)
Result decimals	Defines the number of decimals of the difference in %. This option is only available for % results.	1 2 3* 4 5
Show difference...	Displays the calculated difference in work area and result view. Signed (Default) = Displays the value via algebraic sign. Unsigned = Displays the absolute value.	Signed (Default)* Unsigned
Main unit	Sets the main unit of the weighing process. The available units are model- and country-specific.	g* kg mg µg ct N lb oz ozf GN dwt mom msg tih tils tlf tcl tola baht lb:oz
Readability	Defines the readability (d) of the weighing process. The available readabilities are model-specific.	1d - 0.0001 g* 2d - 0.0002 g 5d - 0.0005 g 10d - 0.001 g 100d - 0.01 g 1000d - 0.1 g

* Factory setting

Stability criteria: Relationship between readability and deviation

Readability	Min. deviation
0.1 mg	0.1 g
0.001 g	1 g
0.01 g	1 g
0.1 g	1 g
1 g	5 g

Setting up the differential weighing application

- Tap .
 - ➔ The screen **Differential weighing – Main configuration** appears.
- Tap **Number of samples**.
 - ➔ The screen **Number of samples** appears.
- Tap **x** to delete the value.
- Enter the number of reference pieces and confirm with **✓**.
- Tap **Back-weighings**.
 - ➔ The screen **Back-weighings** appears.
- Select **1 (Default)**, **2** or **3** and confirm with **✓**.
- Tap **Weighing sequence**.
 - ➔ The screen **Weighing sequence** appears.
- Select **Sample by sample** or **Initial weighings first (Default)** and confirm with **✓**.
- Tap **Accepting mode**.
 - ➔ The screen **Accepting mode** appears.

- 10 Select **Automatic (Default)** or **Manual** and confirm with ✓.
- 11 Activate the option **Use tare container** if required.
- 12 Activate the option **Spill correction** if required.
- 13 Tap **Result decimals** after percented value.
 - ➔ The screen **Result decimals** appears.
- 14 Select the values for the result view, e.g., **Percentage (%)** and the print-out; confirm with ✓.
- 15 Tap **Result decimals**.
 - ➔ The screen **Result decimals** appears.
- 16 Select the number of decimals for the difference in % and confirm with ✓.
- 17 Tap ✓ to return to the application screen.

7.1.9.1 Working with the differential weighing application

There are two different weighing sequence options for differential weighing that are supported by the differential weighing application. For each weighing sequence option (work flow), a maximal version with all options activated and a basic version are described as a sample. Additionally, the user can deviate anytime from the given sequence by choosing the required sample in a list on the balance or identifying the sample ID by a barcode reader (please refer to [Workflow - Free navigation ▶ Page 90]).

7.1.9.1.1 Workflow - Initial weighings first

With this method, the initial weight and the final weight of the sample are determined in a separate operation. All weighing containers can initially be tared before all initial samples are weighed in a second operation. A maximal variant with all options activated and a minimal variant are set out below. It is possible to deviate at any time from a previous weighing sequence.

Performing differential weighing with automatic accept mode and using a tare container

- **Number of samples**, e.g., **2 samples** are defined.
 - **Back-weighings**, e.g., **1 per sample** is selected.
 - **Weighing sequence Initial weighings first (Default)** is selected.
 - **Accepting mode Automatic** is selected.
 - **Use tare container** is activated.
- 1 Tap ▶ to start the process.
 - ➔ The screen **Sample ID** appears.
 - 2 Enter an ID and confirm with ✓.
 - 3 Place a container for the first sample on the weighing pan.
 - ➔ The first tare weight appears in the work title bar.
 - 4 Place the first initial sample in the container.
 - 5 Remove the container with the first sample.
 - ➔ The screen **Sample ID** appears.
 - 6 Enter an ID and confirm with ✓.
 - 7 Place a container for the second sample on the weighing pan.
 - ➔ The second tare weight appears in the work title bar.
 - 8 Place the second initial sample in the container.
 - ➔ A message stating **Initial weighings completed** appears.
 - 9 Tap ✓ to confirm.
 - 10 Remove the container with the second sample.
 - 11 Place the container with the first treated sample on the weighing pan.
 - ➔ The first final weight appears in the value bar.
 - ➔ Sample 1 done appears.

- 12 Remove the sample to continue.
- 13 Place the container with the second treated sample on the weighing pan.
 - ➔ The second final weight appears in the value bar.
 - ➔ Sample 2 done appears.
- 14 Remove the sample to continue.
 - ➔ A message stating **Weighing series completed** appears.
- 15 Tap ✓ to confirm.
- 16 Tap ✓ **Finish and discard data** to return to the application screen.

Performing differential weighing with automatic accept mode while using a tare container and spill correction function

Spill correction allows a spilled substance to be disregarded the weighing result. The weight of the sample spilled on the weighing pan is subtracted from the initial sample weight. The function is available only when a tare container is used.

- **Number of samples**, e.g., **2 samples** are defined.
 - **Back-weighings**, e.g., **1 per sample** is selected.
 - **Weighing sequence Initial weighings first (Default)** is selected.
 - **Accepting mode Automatic** is selected.
 - **Use tare container** is activated.
 - **Spill correction** is activated.
- 1 Tap ► to start the process.
 - ➔ The screen **Sample ID** appears.
 - 2 Enter an ID and confirm with ✓.
 - 3 Place a container for the first sample on the weighing pan.
 - ➔ The first tare weight appears in the work title bar.
 - 4 Place the first initial sample in the container.
 - ➔ The first raw initial weight appears in the value bar.
 - 5 Remove the first sample to apply the spill correction. If anything is spilled on the weighing pan, the weight is subtracted from the result. Clean the weighing pan and continue.
 - ➔ The screen **Sample ID** appears.
 - 6 Enter an ID and confirm with ✓.
 - 7 Place a container for the second sample on the weighing pan.
 - ➔ The second tare weight appears in the work title bar.
 - 8 Place the second initial sample in the container.
 - ➔ The second raw initial weight appears in the value bar.
 - 9 Remove the second sample to apply the spill correction. If anything is spilled on the weighing pan, the weight is subtracted from the result. Clean the weighing pan and continue.
 - ➔ A message stating **Initial weighings completed** appears.
 - 10 Tap ✓ to confirm.
 - 11 Place the container with the first treated sample on the weighing pan.
 - ➔ The first final weight with spill correction appears in the value bar.
 - ➔ Sample 1 done appears.
 - 12 Remove the sample to continue.
 - 13 Place the container with the second treated sample on the weighing pan.
 - ➔ The second final weight with spill correction appears in the value bar.
 - ➔ Sample 2 done appears.
 - 14 Remove the sample to continue.
 - ➔ A message stating **Weighing series completed** appears.
 - 15 Tap ✓ to confirm.
 - 16 Tap ✓ **Finish and discard data** to return to the application screen.

Performing differential weighing with manual accepting mode without using a tare container and spill corrections

- **Number of samples**, e.g., **2 samples** are defined.
 - **Back-weighings**, e.g., **1 per sample** is selected.
 - **Weighing sequence Initial weighings first (Default)** is selected.
 - **Accepting mode Manual** is selected.
 - **Use tare container** and **Spill correction** are deactivated.
- 1 Tap ► to start the process.
 - ➔ The screen **Sample ID** appears.
 - 2 Enter an ID and confirm with ✓.
 - 3 Place the first initial sample on the weighing pan.
 - ➔ The first initial weight appears in the value bar.
 - 4 Tap ✓ to confirm.
 - 5 Remove the sample to continue and confirm with ✓.
 - ➔ The screen **Sample ID** appears.
 - 6 Enter an ID and confirm with ✓.
 - 7 Place the second initial sample on the weighing pan.
 - ➔ The second initial weight appears in the value bar.
 - 8 Tap ✓ to confirm.
 - 9 Remove the sample to continue and confirm with ✓.
 - ➔ A message stating **Initial weighings completed** appears.
 - 10 Tap ✓ to confirm.
 - 11 Place the first treated sample on the weighing pan.
 - ➔ The first final weight appears in the value bar.
 - 12 Tap ✓ to confirm.
 - ➔ Sample 1 done appears.
 - 13 Remove the sample to continue and confirm with ✓.
 - 14 Place the second treated sample on the weighing pan.
 - 15 Tap ✓ to confirm.
 - ➔ Sample 2 done appears.
 - 16 Remove the sample to continue and confirm with ✓.
 - ➔ A message stating **Weighing series completed** appears.
 - 17 Tap ✓ to confirm.
 - 18 Tap ✓ **Finish and discard data** to return to the application screen.

7.1.9.1.2 Workflow - Sample by sample

With this method the tare if applicable, the initial weight and the final weight including all back-weighings are determined one sample after the other in a single operation.

A maximal variant with all options activated and a minimal variant are set out below.

Performing differential weighing with automatic accept mode and using a tare container

- **Number of samples**, e.g., **2 samples** are defined.
 - **Back-weighings**, e.g., **1 per sample** is selected.
 - **Weighing sequence Sample by sample** is selected.
 - **Accepting mode Automatic** is selected.
 - **Use tare container** is activated.
- 1 Tap ► to start the process.
 - ➔ The screen **Sample ID** appears.
 - 2 Enter an ID and confirm with ✓.
 - 3 Place a container for the first sample on the weighing pan.
 - ➔ The first tare weight appears in the work title bar.
 - 4 Place the first initial sample in the container.
 - ➔ The first initial weight appears in the value bar.
 - 5 Remove the container with the first sample.
 - 6 Place the container with the first treated sample on the weighing pan.
 - ➔ The first final weight appears in the value bar.
 - ➔ Sample 1 done appears.
 - 7 Remove the sample to continue.
 - ➔ The screen **Sample ID** appears.
 - 8 Enter an ID and confirm with ✓.
 - 9 Place a container for the second sample on the weighing pan.
 - ➔ The second tare weight appears in the work title bar.
 - 10 Place the second initial sample in the container.
 - ➔ The second initial weight appears in the value bar.
 - 11 Remove the container with the second sample.
 - 12 Place the container with the second treated sample on the weighing pan.
 - ➔ The second final weight appears in the value bar.
 - ➔ Sample 2 done appears.
 - 13 Remove the sample to continue.
 - ➔ A message stating **Weighing series completed** appears.
 - 14 Tap ✓ to confirm.
 - 15 Tap ✓ **Finish and discard data** to return to the application screen.

Performing differential weighing with automatic accept mode while using a tare container and spill correction function

Spill correction allows a spilled substance to be disregarded the weighing result. The weight of the sample spilled on the weighing pan is subtracted from the initial sample weight. The function is available only when a tare container is used.

- **Number of samples**, e.g., **2 samples** are defined.
 - **Back-weighings**, e.g., **1 per sample** is selected.
 - **Weighing sequence Sample by sample** is selected.
 - **Accepting mode Automatic** is selected.
 - **Use tare container** is activated.
 - **Spill correction** is activated.
- 1 Tap ► to start the process.
 - ➔ The screen **Sample ID** appears.
 - 2 Enter an ID and confirm with ✓.
 - 3 Place a container for the first sample on the weighing pan.
 - ➔ The first tare weight appears in the work title bar.
 - 4 Place the first initial sample in the container.
 - ➔ The first raw initial weight appears in the value bar.
 - 5 Remove the first sample to apply the spill correction. If anything is spilled on the weighing pan, the weight is subtracted from the result. Clean the weighing pan and continue.
 - ➔ The first corrected final weight appears in the value bar.
 - 6 Place the container with the first treated sample on the weighing pan.
 - ➔ The first final weight appears in the value bar.
 - ➔ Sample 1 done appears.
 - 7 Remove the sample to continue.
 - ➔ The screen **Sample ID** appears.
 - 8 Enter an ID and confirm with ✓.
 - 9 Place a container for the second sample on the weighing pan.
 - ➔ The second tare weight appears in the work title bar.
 - 10 Place the second initial sample in the container.
 - ➔ The second raw initial weight appears in the value bar.
 - 11 Remove the second sample to apply the spill correction. If anything is spilled on the weighing pan, the weight is subtracted from the result. Clean the weighing pan and continue.
 - 12 Place the container with the second treated sample on the weighing pan.
 - ➔ The second corrected final weight appears in the value bar.
 - ➔ Sample 2 done appears.
 - 13 Remove the sample to continue.
 - ➔ A message stating **Weighing series completed** appears.
 - 14 Tap ✓ to confirm.
 - 15 Tap ✓ **Finish and discard data** to return to the application screen.

Performing differential weighing with manual accept mode without using a tare container and spill corrections

- **Number of samples**, e.g., **2 samples** are defined.
 - **Back-weighings**, e.g., **1 per sample** is selected.
 - **Weighing sequence Sample by sample** is selected.
 - **Accepting mode Manual** is selected.
 - **Use tare container** and **Spill correction** are deactivated.
- 1 Tap ► to start the process.
 - ➔ The screen **Sample ID** appears.
 - 2 Enter an ID and confirm with ✓.
 - 3 Place the first initial sample on the weighing pan.
 - ➔ The first initial weight appears in the value bar.
 - 4 Tap ✓ to confirm.
 - 5 Remove the sample to continue.
 - ➔ The screen **Sample ID** appears.
 - 6 Enter an ID and confirm with ✓.
 - 7 Place the first treated sample on the weighing pan.
 - ➔ The first final weight appears in the value bar.
 - 8 Tap ✓ to confirm.
 - ➔ Sample 1 done appears.
 - 9 Remove the sample to continue and confirm with ✓.
 - ➔ The screen **Sample ID** appears.
 - 10 Enter an ID and confirm with ✓.
 - 11 Place the second initial sample on the weighing pan.
 - ➔ The second initial weight appears in the value bar.
 - 12 Tap ✓ to confirm.
 - 13 Remove the sample to continue.
 - 14 Place the second treated sample on the weighing pan.
 - ➔ The second final weight appears in the value bar.
 - 15 Tap ✓ to confirm.
 - ➔ Sample 2 done appears.
 - 16 Remove the sample to continue and confirm with ✓.
 - ➔ A message stating **Weighing series completed** appears.
 - 17 Tap ✓ to confirm.
 - 18 Tap ✓ **Finish and discard data** to return to the application screen.

7.1.9.1.3 Workflow - Free navigation

Regardless of which weighing sequence option is chosen (**Sample by sample** or **Initial weighings first (Default)**), the default workflow can be interrupted and each sample and weighing process can be performed in a sequence according to the user's requirements. The required sample can be selected either by navigating to the result table via the work title bar or swiping from sample to sample on the work title bar. Especially convenient is to identify the sample before the back-weighing by scanning its ID with a barcode reader. The balance does then automatically show the correct sample to proceed with the weighing process.



Performing a free navigation workflow

- **Weighing sequence Sample by sample** or **Initial weighings first (Default)** is selected.
- **Accepting mode Automatic** or **Manual** is selected.
- **Use tare container** is activated or deactivated.
- Number of samples is fixed.

- 1 Tap ► to start the process.
 - ➔ The screen **Sample ID** appears.
- 2 Enter an ID and confirm with ✓.
- 3 Place a container for the first sample on the weighing pan.
 - ➔ The first tare weight appears in the work title bar.
- 4 The following samples can be handled individually.

There are 2 alternatives to the standard workflow. The following samples can be handled individually. See below for examples.

Execute the workflow via the work title bar and the result table

- 1 Tap the work title bar.
 - ➔ A dialog screen appears.
- 2 Select the sample to be processed by tapping  or by searching the sample tapping on .
- 3 Follow the instructions on the screen.
- 4 Continue with the work sequence in the same order until all samples have been processed.
 - ➔ At the end, the message **Weighing series completed** appears.
- 5 Tap ✓ to confirm.



Note

When tapping on the ✓ icon an additional back-weighing step can be added for this respective sample.

Execute the workflow with swipes over the work title bar

Swipe the work title bar horizontally to navigate between the different samples that still have missing values.

- 1 Swipe the work title bar.
 - ➔ A dialog screen appears.
- 2 Select the sample to be processed by swiping.
 - ➔ Only the samples with missing values are displayed.
- 3 Follow the instructions on the screen.
- 4 Continue with the work sequence in the same order until all samples have been processed.
 - ➔ At the end, the message **Weighing series completed** appears.
- 5 Tap ✓ to confirm.

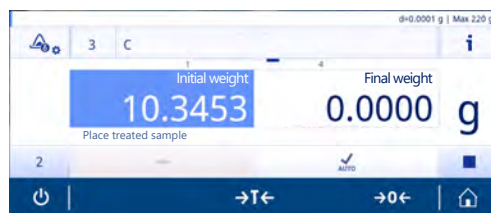

Execute the workflow by using a barcode reader

When a barcode reader is connected and installed it can be used for two purposes. First, the ID values can be scanned in and second, which is very convenient, the sample can be identified automatically when executing the back-weighing. Once you want to execute a back-weighing for a specific sample, just scan its Sample ID and the balance will show directly the correct information to proceed with the process.

7.1.9.1.4 Formulae used to calculate differential weighing results

Statistical results are calculated with the last difference result of the samples that lies within the acceptance range. x = back-weighing number (1...3).

Difference

$$\text{Diff. } x = \text{back-weighing } x - \text{initial weight}$$

Difference in %

$$\text{Diff. } \% x = (\text{diff. } x / \text{initial weight}) * 100\%$$

Absolute %

$$\text{Abs. } \% x = (\text{back-weighing } x / \text{initial weight}) * 100\%$$

Atro Moisture Content

$$\text{Atro AM } x = ((\text{back-weighing } x - \text{initial weight}) / \text{residual weight } x) * 100\%$$

Atro Dry Content

$$\text{Atro AD } x = (\text{initial weight} / \text{back-weighing } x) * 100\%$$

7.1.10 Density

Navigation:  **Activities** >  **Activities - Weighing and other applications** >  **Density**

Density allows the density of solid bodies and liquids to be determined.

The density is determined via the Archimedes principle, according to which a body immersed in a fluid undergoes an apparent loss in weight which is equal to the weight of the fluid it displaces.

To determine the density of solid bodies, we recommend using the optional density kit, which contains all attachments and aids needed for convenient and precise density determination. To determine the density of liquids, a sinker is also required. This can be obtained from your METTLER TOLEDO dealer.

The statistics function can be activated; information on this topic can be found in [Statistics ▶ Page 58].

Density – Main configuration

The following options can be set:

Parameter	Description	Values
Method	Depending if the weight type is solid or liquid.	Solid* Liquid
Auxiliary liquid	Select the auxiliary liquid.	H2O* Ethanol Free...
Sinker volume	This option is only available when Liquid is active.	(0.1 ... 500.0 cm ³)
Result decimals	Defines the number of decimal places density in g/cm ³ .	1 2 3* 4 (depending on the balance type)
Main unit	Sets the main unit of the weighing process. The available units are model- and country-specific.	g* kg mg µg ct N lb oz ozt GN dwt mom msg flh tfs tft tcl tola baht lb:oz

* Factory setting

Determination of density of solids

- 1 Tap .
➔ The screen **Density – Main configuration** appears.
- 2 Tap **Method**.
➔ When **Solid** has been activated (default value), the **Auxiliary liquid** appears in the list.
- 3 Tap **Auxiliary liquid**.
➔ The screen **Auxiliary liquid** appears.
- 4 Define the **Auxiliary liquid** that is used. Select between **H2O** for distilled water, **Ethanol** or **Free...** for a freely definable auxiliary liquid.
- 5 Tap ✓ to confirm.
➔ The selected **Auxiliary liquid** defines the next steps:
➔ The dialog screen **Temperature in °C** appears.
- 6 Enter the **Temperature in °C** for **Ethanol** and **H2O**.
- 7 **Auxiliary liquid name** and **Density in g/cm³** must be defined for the option **Free....**
- 8 Tap ✓ to confirm.
➔ The screen **Density – Main configuration** appears.
- 9 Tap ✓ to return to the application screen.
➔ The balance is prepared for determining the density of solids.

Determining the density for solids

- The balance has been configured to determine the density of solids.
- 1 Tap ► to start the process.
 - ➔ The dialog screen **Sample weight in air** appears.
- 2 Place the solid mass on the weighing pan.
- 3 Tap ✓ to confirm.
 - ➔ The dialog screen **Sample weight in liquid** appears.
- 4 Immerse solid in the liquid.
- 5 Tap ✓ to confirm.
 - ➔ The results are now displayed.
- 6 Tap  to publish the results according to the configurations.
- 7 Tap ✓ to return to the application screen.

Determination of density for liquids

- 1 Tap .
 - ➔ The screen **Density – Main configuration** appears.
- 2 Tap **Method**.
- 3 Tap **Liquid**.
- 4 Tap ✓ to confirm.
 - ➔ When **Liquid** has been activated, **Sinker volume** appears in the list.
- 5 Tap **Sinker volume**.
 - ➔ The dialog screen **Sinker volume in cm³** appears.
- 6 Tap ✕ to delete the value.
- 7 Enter the volume of the sinker.
- 8 Tap ✓ to confirm.
 - ➔ The screen **Density – Main configuration** appears.
- 9 Tap ✓ to return to the application screen.

Determining the density of liquids

- The balance has been configured to determine the density of liquids.
- 1 Tap ► to start the process.
 - ➔ The dialog screen **Sinker in air** appears.
- 2 Place the sinker on the weighing pan.
- 3 Tap ✓ to confirm.
 - ➔ The dialog screen **Sinker in liquid** appears.
- 4 Immerse the sinker.
- 5 Tap ✓ to confirm.
 - ➔ The results are now displayed.
- 6 Tap  to publish the results according to the configurations.
- 7 Tap ✓ to return to the application screen.

7.1.11 Factor weighing

Navigation:  **Activities** >  > **Activities - Weighing and other applications** >  **Factor weighing**

The application **Factor weighing** multiplies or divides a pre-defined factor by the measured weight value (in grams) and calculates it to a predefined number of decimal places.

The permitted range for the steps depends on the pre-defined factor and the resolution of the balance.

The statistics function can be activated; information on this topic can be found in [Statistics ▶ Page 58].



Factor weighing – Main configuration

The following options can be set:

Parameter	Description	Values
Factor, step	Defines the factor and the step.	Factor Step
Secondary information	<p>Activates or deactivates the secondary information displayed on screen.</p> <p>Additional unit* Selects the secondary information displayed on screen. The available units are model- and country-specific.</p> <p>Current tare Current tare weight.</p>	ON* OFF
Target and tolerances	<p>Defines the target weight and tolerances.</p> <p>Target weight Predefines a target weight. The value can be selected manually or by weighing.</p> <p>Upper tolerance Defines the upper tolerance.</p> <p>Lower tolerance Defines the lower tolerance.</p> <p>If the value for Target weight, Upper tolerance or Lower tolerance has been defined, the option title Target and tolerances will be replaced by the defined values.</p>	ON OFF* Numerical value (depending on the balance type)

* Factory setting









Defining factor and step

- 1 Tap .
 - ➔ The screen **Factor weighing – Main configuration** appears.
- 2 Tap **Factor, step**.
 - ➔ The dialog screen **Factor – Multiplication** appears.
- 3 Tap **x** to delete the value.
- 4 Define **Factor**.
- 5 Tap  to change the operation from **Multiplication** to **Division** or vice versa.
- 6 Tap **✓**.
- 7 Tap .
 - ➔ The dialog screen **Step** appears.
- 8 Define **Step**.
- 9 Tap **✓** to confirm.
 - ➔ The screen **Factor weighing – Main configuration** appears.
- 10 Tap **✓** to return to the application screen.

7.2 Activities - Adjustments and tests

Navigation:  > 

Activities - Adjustments and tests consists of the following elements:

-  **FACT**, see [Fully automatic adjustment (FACT) ▶ Page 95]
-  **Internal Adjustment**, see [Internal adjustment ▶ Page 96]
-  **External Adjustment**, see [External adjustment ▶ Page 96]
-  **Fine adjustment**, see [Fine adjustment (model-dependent) ▶ Page 97]
-  **Touch screen adjustment**, see [Touch screen adjustment ▶ Page 97]
-  **Level indicator center adjustment**, see [Level indicator center adjustment ▶ Page 97]
-  **Routine test**, see [Routine test ▶ Page 98]
-  **Repeatability test**, see [Repeatability test ▶ Page 99]

7.2.1 Activities reports configuration

Define which information should be published in report printouts and report files. Select the adjustment or test activity and tap the activities settings symbol in the upper left corner to define the activity.

The general printout and export behavior, e.g., manual/automatic is shared by all activities and can be defined in the general settings area "Publishing".

The activities settings can only be changed if no measurement is in progress.

The available options may differ depending on the activity. Most activities have the following options:

-  **Main configuration**
-  **Reports configuration**

The following options can be set:

Parameter	Description	Values
Title information	Activates or deactivates the title information.	ON OFF*
	Defines if the adjustment/test name and data and time appears on the report.	Report title Date, time
Balance information	Activates or deactivates the balance information.	ON OFF*
	Defines which balance information appears on the report.	Balance type Balance identification Software version Serial number (SNR) Leveling status
Footer	Activates or deactivates the footer.	ON OFF*
	Defines which information appears in the footer. The user name is only listed, when user management is activated.	Date, time User name Signature line Empty lines

* Factory setting

7.2.2 Fully automatic adjustment (FACT)

Navigation:  **Activities** >  **Activities - Adjustments and tests** >  **FACT**

FACT is activated as a default value. If the **FACT** function is not activated, all functionalities, such as temperature and time, are inactive.

FACT means that the balance adjusts itself based on the following criteria:

- if the conditions change (temperature difference min. 2 °C), which may lead to a noticeable deviation in the measurement.
- on a predefined date and time programmed by the user.

Defining FACT

The date and time of FACT can be defined as follows:

- 1 Tap **FACT**.
- 2 Activate **Fully automatic adjustment (FACT)**.
 - ➔ The dialog screen **Fully automatic adjustment (FACT)** appears.
- 3 Select the time (hours : minutes) using the pick buttons.
- 4 Tap ✓ to confirm.
 - ➔ The time underneath **FACT** has been updated and displays the time of the daily adjustment.
- 5 Tap ← to return to the application screen.

When setting the time, hold the pick button to scroll faster.



If a predefined criterion is due, the flashing FACT status icon appears in the display. The balance indicates that it wishes to perform a FACT adjustment.

- 1 Unload the balance.
 - 2 Do not select any key.
 - ➔ Adjustment starts automatically.
- ➔ The status icon extinguishes after successful adjustment.

7.2.3 Internal adjustment

Navigation: **Activities** > **Activities - Adjustments and tests** > **Adjust internal**

If the balance is configured and connected to a printer, the results of the adjustment process will be printed.

Perform an internal adjustment manually

- 1 Unload the balance.
- 2 Tap **Adjust internal**.
- 3 Tap ►.
 - ➔ The internal adjustment procedure will start. The screen displays **Adjustment ongoing...**
 - ➔ When the internal adjustment procedure is successfully completed, the results of the internal adjustment will appear.
- 4 Tap ✓ to confirm.
 - ➔ The screen **Activities - Adjustments and tests** appears.
- 5 Tap ← to return to the application screen.

7.2.4 External adjustment

Navigation: **Activities** > **Activities - Adjustments and tests** > **Adjust external**

Legal-for-trade

Because of certification legislation, approved balances cannot be adjusted with an external weight (depending on the certification legislation of the selected country).

- 1 Tap **Adjust external**.
 - ➔ The dialog screen **Adjustment weight** appears.
- 2 Tap to define the adjustment weight according to the weight certificate.
- 3 Tap ✕ to delete the value.
- 4 Enter the new value and confirm with ✓.
- 5 Prepare the adjustment weight and tap ► to start the adjustment process.
- 6 Load the adjustment weight in the center of the weighing pan.
- 7 Unload the adjustment weight from the weighing pan.
 - ➔ When the external adjustment procedure is successfully completed, the result will appear.

- 8 Tap ✓ to confirm.
 - ➔ The screen **Activities - Adjustments and tests** appears.
- 9 Tap ← to return to the application screen.

7.2.5 Fine adjustment (model-dependent)

Navigation:  >  **Activities - Adjustments and tests** >  **Adjust fine**

The value of the internal adjustment weight can be individually adjusted in a very small range via the **Fine adjustment** function.

- Use only certificated weights.
- Make sure that the environmental conditions are correct.
- The balance must be leveled.
- Balance and test weights must observe the operating temperature.
- For fine adjustments, we recommend contacting a balance expert or a METTLER TOLEDO representative.

Legal-for-trade

Approved models are not able to be adjusted with this function.

Performing fine adjustment

- Adjusting weight is prepared.
- 1 Tap  **Adjust fine**.
 - ➔ The dialog screen **Reference weight** appears.
 - 2 Tap ✕ to delete the value.
 - 3 Enter the weight value according to the certificate.
 - 4 Tap ✓ to confirm.
 - 5 Tap ▶ to start the process.
 - 6 Place the adjustment weight in the center of the weighing pan.
 - 7 Remove the adjustment weight.
 - ➔ The result will appear once the fine adjustment procedure is successfully completed.
 - 8 Tap ✓ to confirm.
 - ➔ The screen **Activities - Adjustments and tests** appears.
 - 9 Tap ← to return to the application screen.
- Tap ↺ to reset the defined reference weight back to the default value.

7.2.6 Touch screen adjustment

Navigation:  **Activities** >  **Activities - Adjustments and tests** >  **Adjust touch**

If the balance does not respond correctly when a certain area of the display is tapped, the touch screen can be adjusted with **Adjust touch**.

- 1 Tap **Adjust touch**.
 - ➔ Touch screen ongoing. Please wait until the screen **Done** appears.
- 2 Tap ✓ to confirm.
 - ➔ The screen **Activities - Adjustments and tests** appears.
- 3 Tap ← to return to the application screen.

7.2.7 Level indicator center adjustment

Navigation:  **Activities** >  **Activities - Adjustments and tests** >  **Adjust level**

The adjustment sets the exact center position of the level indicator and corrects any possible shifts.



Note

Run the level indicator center adjustment only when the electronic in/out level notification (status icon) and visual bubble position do not match.

- 1 Tap **Adjust level**.
 - ➔ The screen **Level indicator center adjustment** appears.
- 2 Tap ✓ to confirm.
 - ➔ The screen **Level indicator center adjustment** appears.
- 3 Follow the instructions and confirm with ✓.
 - ➔ The screen **Done Level indicator Adjustment** appears.
- 4 Tap ✓ to confirm.
- 5 Tap ← to return to the application screen.

7.2.8 Routine test

Navigation: **Activities** > **Activities - Adjustments and tests** > **Routine test**

The **Routine test** function allows the sensitivity of the balance to be set for periodic tests.

The set values appear at the top of the screen in the weighing information bar. The bar works as a shortcut.

Routine test – Main configuration

The following options can be set:

Parameter	Description	Values
Test weight in g	Defines the test weight.	Numerical value (depending on the balance type)
± Control limit in g	Defines the control limit.	Numerical value (depending on the balance model)
± Warning limit in g	Activates or deactivates the warning limit.	ON* numerical value (depending on the balance model) OFF
Use tare container	Activates or deactivates the use of a tare vessel.	ON OFF*

* Factory setting

Setting the test weight, control limits and warning limits

- 1 Tap .
 - ➔ The screen **Routine test – Main configuration** appears.
- 2 Tap **Test Weight**.
 - ➔ The dialog screen **Test weight in g** appears.
- 3 Tap ✕ to delete the value.
- 4 Enter the new value.
- 5 Tap .
 - ➔ The dialog screen **± Control limit in g** appears.
- 6 Tap ✕ to delete the value.
- 7 Enter the new value.
- 8 Tap .
 - ➔ The dialog screen **± Warning limit in g** appears.
- 9 Tap ✕ to delete the value.
- 10 Enter the new value and confirm with ✓.
- 11 Activate or deactivate the option **Use tare container** if required.

- 12 Tap ✓ to confirm.
- 13 Tap ← to return to the application screen.

Performing a routine test

- The routine test options **Test weight in g**, **± Control limit in g** and **± Warning limit in g** are defined.
 - The test weight is prepared.
- 1 Tap ▶ to start the process.
 - 2 Place the test weight in the center of the weighing pan.
 - ➔ During the test, the screen shows **Waiting for stable weight....**
 - ➔ When the test is finished, the screen shows **Please unload weight.**
 - 3 Remove the test weight from the weighing pan.
 - ➔ When the routine test is successfully completed, the result appears.
 - 4 Tap ✓ to confirm.
 - 5 Tap ← to return to the application screen.



7.2.9 Repeatability test

Navigation:  **Activities** >  **Activities - Adjustments and tests** >  **Repeatability test**

A specific number of internal weight tests can be defined via the **Repeatability test** function.

The set number of tests appears at the top of the screen in the weighing information bar. The bar works as a shortcut.

Setting the number of repetitions

- 1 Tap  .
 - ➔ The dialog screen **Repeatability test - Repetitions** appears.
- 2 Tap ✕ to delete the value.
- 3 Enter the number of repetitions. The number must be between 5 and 100.
- 4 Tap ✓ to confirm the number of repetitions.
- 5 Tap ▶ to start the process.
 - ➔ The balance executes the defined number of tests. The message **Test ongoing, please wait...** appears on the display during the process. The process can be aborted by tapping ✕.
 - ➔ After the test is finished, an overview with the test results appears on the screen.
- 6 Tap ✓ to confirm.
- 7 Tap ← to return to the application screen.

8 Communication with Peripheral Devices and Networks

This section lists some typical examples of where the balance can communicate with peripheral devices and networks.

8.1 USB - interface and installation

Before connecting the balance via the USB device interface to a PC and using either the **HOST** or **PC-Direct** function, the appropriate METTLER TOLEDO USB driver has to be assigned to the PC first. The USB driver can be found on www.mt.com/labweighing-software-download. If you have any questions, please contact a METTLER TOLEDO representative.



Note

If you connect the balance via USB to the PC before installing the METTLER TOLEDO USB driver, Windows will automatically install the wrong driver.

Requirements

- Balance with USB device interface
- PC with one of the following Microsoft Windows® 32-bit/64-bit operating systems: Win 7 (SP1), Win 8 or Win 10
- Administrator rights for installing software
- USB connection cable to link PC to balance

Download USB driver

- 1 Connect to the internet.
- 2 Go to the site www.mt.com/labweighing-software-download.
- 3 Click **Download Driver** in section **USB Driver for Advanced and Standard level laboratory balances**.
 - ➔ A pop-up window with interactions appears.
- 4 Click, e.g., **Open**.
 - ➔ The extract screen appears.
- 5 Extract the file **MT_Generic_USB_Serial_Port_Driver_SW_en_vx.xx.x.x.zip** to your specified location.
- 6 Right-click on the downloaded installation program **MT_Generic_USB_Serial_Port_Driver_SW_en_vx.xx.x.x.exe** and select **Run as Administrator**.
- 7 If a safety warning appears, confirm windows to perform the installation.
- 8 Click **Next** and follow the installer's instructions.

Installing the balance

- 1 Switch the balance **off**.
- 2 Connect the balance to the preferred USB port on the PC.
- 3 Switch the balance **on**.

8.2 Send weight value via USB or RS232C to a PC using PC-Direct

The PC-Direct function of the balance allows you to transfer weight values from the balance to a Windows application. The weight value displayed on the balance is transferred to the cursor position in, e.g., Excel or Word.

The data is transferred via USB or via the serial RS232C interface.

The weight value is transferred without the unit.

Requirements

- PC with one of the following Microsoft Windows® 32-bit/64-bit operating systems: Win 7 (SP1), Win 8 or Win 10
- Serial interface RS232C or USB
- Administrator rights for installing the SerialPortToKeyboard software (if data transfer is via RS232C)
- Windows application, e.g., Excel
- Connection between balance and PC via RS232C or USB cable

8.2.1 PC-Direct via USB

The balance can send data (as a keyboard) to the PC used for PC applications, e.g., Excel. The balance sends the weight value without the unit to the PC.

Use the USB connection cable to connect the balance with the PC. Connect the USB cable to the USB device (type B) on the balance.

- The balance must be disconnected from the PC.

1 Tap .

2 Tap  **General configuration and data**.

3 Tap  **Devices and services**.

➔ The screen **Devices and services** appears.

4 Tap .

➔ The screen **Device/service type** appears.

5 Select **PC-Direct** and confirm with ✓.

➔ The screen **Connection type** appears.

6 Tap **USB Device** and confirm with ✓.

➔ The screen **PC-Direct – Document on PC** appears.

7 If necessary, change the other settings, e.g., **End of line** and confirm with ✓.

8 Tap ✓ to confirm.

➔ The screen **Devices and services** appears.

9 Tap  to return to the previous screen.

10 Tap  **Publishing**.

➔ The screen **Publishing** appears.

11 Tap **PC-Direct (USB Device)**.

12 Tap **Send data**.

➔ The screen **Send data** appears.

13 Select the transmission mode for single values and result values, e.g., **Manual, stable** and confirm with ✓.

14 Tap  to return to the previous screen.

15 **Connect the balance to the PC.**

16 Place the sample on the weighing pan.

17 Press , the next stable weight will be sent to the cursor position of your application.

8.2.2 PC-Direct via RS232C

8.2.2.1 Installing SerialPortToKeyboard software

The operation of PC-Direct via serial port RS232C requires the installation of **SerialPortToKeyboard** on your host computer. The file **SerialPortToKeyboard** can be found on www.mt.com/labweighing-software-download. If you have any questions, please contact a METTLER TOLEDO representative.

Download SerialPortToKeyboard

- 1 Connect to the internet.
- 2 Go to the site www.mt.com/labweighing-software-download.
- 3 Click **Download Software and Instructions** in section **SerialPortToKeyboard software for Advanced and Standard level laboratory balances**.
 - ➔ A pop-up window with interactions appears.
- 4 Click, e.g., **Open**.
 - ➔ The extract screen appears.
- 5 Extract the file **SerialPortToKeyboard_V_x.xx_installer_and_instructions.zip** to your specified location.
- 6 Right-click on the downloaded installation program **SerialPortToKeyboard_V_x.xx.exe** and select **Run as Administrator**.
- 7 If a safety warning appears, confirm windows to perform the installation.
- 8 Click **Next** and follow the installer's instructions.

Checking operation

- 1 Start **SerialPortToKeyboard** (RS232C)
- 2 Start Excel (or another application) on the computer.
- 3 Activate a cell in Excel.

Settings on the PC





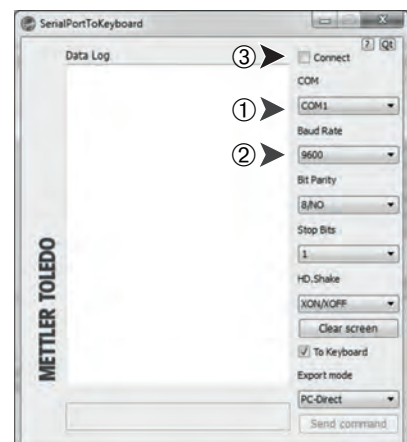

Settings for SerialPortToKeyboard

- 1 Select the serial port **COM** for the connection with the balance.
- 2 Set the **Baud Rate** to **9600**.
- 3 Activate **Connect**.
 - Closing the window terminates the session.



According to your selected **End of line** option, the displayed values will appear, e.g., in the column one after the other one in the different rows.

8.2.2.2 Settings on the balance







- The balance is connected to the PC via an RS232 cable.
- 1 Tap .
- 2 Tap  **General configuration and data**.
- 3 Tap  **Devices and services**.
 - ➔ The screen **Devices and services** appears.
- 4 Tap .
- ➔ The screen **Device/service type** appears.
- 5 Select **PC-Direct** and confirm with ✓.
 - ➔ The screen **Connection type** appears.
- 6 Tap **RS232** and confirm with ✓.
 - ➔ The screen **PC-Direct – Document on PC** appears.
- 7 If necessary, change the other settings, e.g., **End of line** and confirm with ✓.
- 8 Tap ✓ to confirm.
- 9 Tap  to return to the previous screen.
- 10 Tap  **Publishing**.
 - ➔ The screen **Publishing** appears.
- 11 Tap **PC-Direct (RS232)**.
 - ➔ The screen **Send data** appears.
- 12 Select the transmission mode for single values and result values, e.g., **Automatic, stable** and confirm with ✓.
- 13 Tap ✓ to confirm.
 - ➔ The screen **Publishing** appears.
- 14 Tap  to return to the previous screen.
- 15 Place the sample on the weighing pan.
 - ➔ The next stable weight will be sent automatically to the cursor position of your application.

8.3 Collecting measurement results and balance details with EasyDirect Balance

EasyDirect Balance from METTLER TOLEDO is a PC software to collect, analyze, store and export measurement results and balance details from up to 10 balances. EasyDirect Balance supports all Advanced and Standard Level Laboratory Balances and many legacy models from METTLER TOLEDO. For more information and to download a trial version of the software, please refer to www.mt.com/EasyDirectBalance.

The balance can be connected either via LAN or RS232, but the full functionality is only available with a LAN connection. When using an RS232 connection, only a limited set of data can be collected by EasyDirect Balance. Please refer to the table "Data available to EasyDirect Balance, depending on the data interface" for more details.

Configure the balance

- The balance is connected with an Ethernet cable to the LAN.
 - LAN is activated on the balance. For more information, please refer to "**Network and Bluetooth**".
- 1 Tap .
 - 2 Tap  **General configuration and data**.
 - 3 Tap  **Devices and services**.
 - ➔ The screen **Devices and services** appears.
 - 4 Tap .
 - ➔ The screen **Device/service type** appears.
 - 5 Select **EasyDirect Balance** and confirm with ✓.
 - ➔ The screen **Connection type** appears.
 - 6 Tap **Network: LAN** and confirm with ✓.
 - ➔ The screen **Add Network service – Port** appears.
 - 7 If necessary, change the port number and confirm with ✓.
 - ➔ The screen **EasyDirect Balance – Software on PC** appears.
 - 8 Tap ✓ to confirm.
 - 9 Tap  to return to the **General configuration and data** screen.
 - 10 Tap  **Publishing**.
 - ➔ The screen **Publishing** appears.
 - 11 Tap **Send data**.
 - ➔ The screen **Send data** appears.
 - 12 Select the transmission mode, e.g., **Automatic, stable** and confirm with ✓.
 - 13 Tap ✓ to confirm.
 - 14 Tap  to return to the previous screen.

Please be aware that the report configuration does not apply to EasyDirect Balance; all available data is sent according the details on the table "Data available to EasyDirect Balance, depending on the data interface".

Transfer data

- 1 Install EasyDirect Balance on your PC.
- 2 Follow the instructions to add the balance in EasyDirect Balance.
- 3 Publish the data from the balance either manually or automatically.



Note

- To connect the balance manually via LAN, you need to know the IP address and port number of your balance, which can be displayed when selecting the EasyDirect Balance under "Services" in the "Devices and service" menu.
- The PC with EasyDirect Balance and the balances must be connected to the same LAN, e.g., **168.125.x.xxx**.
- When connecting the balance via LAN, certain information is also sent to EasyDirect Balance, independently of any publishing activity.

Data available to EasyDirect Balance, depending on the data interface









		LAN	RS232
Balance details	Balance model	✓	✓
	Balance ID	✓	✓
	Balance serial number	✓	✓
	Balance capacity	✓	✓
	Balance readability	✓	–
	Level status	✓	–
	Adjustment status	✓	–
	Service status	✓	–
	Connection status	✓	–
Measurement results	Gross/Tare/Net weight	✓	✓
	Unit 1 and Unit 2 (incl. pcs, %)	✓	✓
	Stability condition	✓	✓
	Date and Time	✓	✓
	Sample and task IDs	✓	✓
	Target and tolerances	✓	–
	User name	✓	–
	Application specific results and parameters	✓	–
	Supported activities	Weighing	✓
Counting		✓	✓
Percent weighing		✓	✓
Factor weighing		✓	✓
Check weighing		✓	–
Dynamic weighing		✓	–
Formulation		✓	–
Totaling		✓	–
Back-weighing		✓	–
Differential weighing		✓	–
Density		✓	–
Adjustments		✓	–
Routine test		✓	–
Repeatability test		✓	–

8.4 Connect via USB to a printer and print weighing results

Prerequisite













- The printer is connected to the power supply.
- Printer is switched on.
- The printer is connected to the balance via USB cable. Do not connect the printer with the balance, before it is correctly powered on.

The following example shows the option to automatically print the next stable value.

- 1 Tap .
- 2 Tap  **General configuration and data**.
- 3 Tap  **Devices and services**.
 - ➔ The screen **Devices and services** appears.
- 4 The connected USB device appears automatically.
- 5 Tap the connected printer, e.g., **P-56/58** and confirm with ✓.
 - ➔ The screen **P-56/58 – Excellence lab printer** appears.
- 6 Tap  for the printer test.
 - ➔ Test page printed. Check the printout.
- 7 Tap ✓ to confirm.
- 8 Tap  to return to the previous screen.
 - ➔ The screen **Device/service type** appears.
- 9 Tap  to return to the **General configuration and data** screen.
- 10 Tap  **Publishing**.
 - ➔ The screen **Publishing** appears.
- 11 Tap **Print and export report**.
 - ➔ The screen **Print and export – General configuration** appears.
- 12 Tap  **Single values reports**.
 - ➔ The screen **Single values reports** appears.
- 13 Select the transmission mode, e.g., **Automatic, stable** and confirm with ✓.
- 14 Tap ✓ to confirm.
- 15 Tap  to return to the previous screen.
- 16 Place the sample on the weighing pan.
 - ➔ The next stable weight will be sent automatically.









8.5 Connect via LAN to a P-50 printer and print weighing results

The following example shows the option to automatically print the next stable value.

- Balance and P-50 printer are connected via Ethernet cables to the same LAN.
- 1 Tap .
- 2 Tap  **General configuration and data**.
- 3 Tap  **Network and Bluetooth**.
 - ➔ The screen **Network and Bluetooth** appears.
- 4 Tap  **LAN**.
 - ➔ The screen **LAN** appears.
- 5 Tap **ON** to activate **LAN** and confirm with ✓.
 - ➔ LAN connection is established.
- 6 Tap  to return to the **General configuration and data** screen.
- 7 Tap  **Devices and services**.
 - ➔ The screen **Devices and services** appears.
- 8 Tap .
- ➔ The screen **Device/service type** appears.
- 9 Select the device to be configured as **P-56/58** by tapping.
- 10 Tap ✓ to confirm.
 - ➔ The screen **Connection type** appears.
- 11 Tap **Network: LAN** and confirm with ✓.
 - ➔ The screen **Add Network service – IP address** appears.
- 12 Enter the IP address of the printer and confirm with ✓.
 - ➔ The screen **Add Network service – Port** appears.
- 13 If necessary, change the port number and confirm with ✓.
 - ➔ The screen **P-56/58 – Excellence lab printer** appears.
- 14 Tap  for the printer test.
 - ➔ Test page printed. Check the printout.
- 15 Tap ✓ to confirm.
- 16 Tap  to return to the **General configuration and data** screen.
- 17 Tap  **Publishing**.
 - ➔ The screen **Publishing** appears.
- 18 Tap **Print and export report**.
 - ➔ The screen **Print and export – General configuration** appears.
- 19 Tap  **Single values reports**.
 - ➔ The screen **Single values reports** appears.
- 20 Select the transmission mode, e.g., **Automatic, stable** and confirm with ✓.
- 21 Tap ✓ to confirm.
- 22 Tap  to return to the previous screen.
- 23 Place the sample on the weighing pan.
 - ➔ The next stable weight will be sent automatically.

8.6 Connect via Bluetooth to a P-50 printer and print weighing results









The following example shows the option to automatically print the next stable value.

- The wireless dongle MTICWD-100 is connected to the balance and the Bluetooth to RS32 adapter is connected to the printer.
 - Bluetooth is activated on the balance. For more information, please refer to "**Network and Bluetooth**".
 - Printer is switched on.
- 1 Tap .
 - 2 Tap  **General configuration and data**.
 - 3 Tap  **Devices and services**.
 - ➔ The screen **Devices and services** appears.
 - 4 Tap .
 - ➔ The screen **Device/service type** appears.
 - 5 Tap the printer you would like to connect to, e.g., **P-56/58** and confirm with ✓.
 - ➔ The screen **Connection type** appears.
 - 6 Tap **Bluetooth** and confirm with ✓.
 - ➔ The screen **Add bluetooth device** appears.
 - 7 Select the device to be configured as **P-56/58** by tapping.
 - 8 Tap ✓ to confirm.
 - ➔ The screen **Password** appears.
 - 9 Tap ✓ to confirm.
 - ➔ The screen **P-56/58 – Excellence lab printer** appears.
 - 10 Tap ✓ to confirm.
 - ➔ The screen **Devices and services** appears.
 - 11 Tap  to return to the **General configuration and data** screen.
 - 12 Tap  **Publishing**.
 - ➔ The screen **Publishing** appears.
 - 13 Tap **Print and export report**.
 - ➔ The screen **Print and export – General configuration** appears.
 - 14 Tap  **Single values reports**.
 - ➔ The screen **Single values reports** appears.
 - 15 Select the transmission mode, e.g., **Automatic, stable** and confirm with ✓.
 - 16 Tap ✓ to confirm.
 - 17 Tap  to return to the previous screen.
 - 18 Place the sample on the weighing pan.
 - ➔ The next stable weight will be sent automatically.

8.7 Connect to web access via LAN

Web access enables you to connect your balance to any web browser on your mobile device or PC. You can view results and perform basic balance operations (tare, zero and print) from anywhere.

- Balance is connected via a Ethernet cable to the LAN. The device on which the browser is running is connected to the same network.

- 1 Tap .
- 2 Tap  **General configuration and data**.
- 3 Tap  **Network and Bluetooth**.
 - ➔ The screen **Network and Bluetooth** appears.
- 4 Tap  **LAN**.
 - ➔ The screen **LAN** appears.
- 5 Tap **ON** to activate **LAN** and confirm with ✓.
 - ➔ LAN connection is established.
- 6 Tap  **Devices and services**.
 - ➔ The screen **Devices and services** appears.
- 7 Tap .
- 8 Select **Web access** and confirm with ✓.
 - ➔ The screen **Connection type** appears.
- 9 Tap **Network: LAN** and confirm with ✓.
 - ➔ The screen **Web access – Remote balance** appears.
- 10 Tap ✓ to confirm.
- 11 Tap  to return to the previous screen.
- 12 Tap  to open the general balance information menu.
 - ➔ The balance information menu screen appears.
- 13 Check IP address (**Server address**) of the balance.
- 14 Start your web browser.
- 15 Enter the **Server address** of the balance, e.g., `http://172.24.4.129`.
 - ➔ The balance screen appears.



Note

The weight value is only shown in the web browser, when the balance is in the home screen.

8.8 Connect a USB barcode reader and scan the barcode

The following example shows how to scan the sample ID via a barcode reader.

Use the USB connection cable to connect the barcode reader to a balance.









Only the balance settings are changed for this menu item.







Refer to your barcode reader's documentation for information about the barcode reader settings.

The barcode reader must be configured as USB keyboard (with standard key encoding).

Settings on the balance









- USB barcode reader is connected to the balance.
- 1 Tap  in the status information field on the balance screen.
 - ➔ The screen **Notifications** appears.
- 2 Tap **External input device connected**.
 - ➔ The screen **External input device connected** appears.
- 3 Tap  **Barcode reader** and confirm with ✓.
- 4 Tap  to return to the previous screen.
- 5 Tap .
- 6 Tap  **General configuration and data**.
- 7 Tap  **Devices and services**.
 - ➔ The screen **Devices and services** appears.
- 8 Tap  **Barcode reader**.
 - ➔ The screen **Barcode reader – External input device** appears.
- 9 Check the **End of line** setting. The setting must be the same as the barcode reader.
- 10 Tap ✓ to confirm.
- 11 Tap  to return to the previous screen.

Typical setup to use the barcode reader

- 1 Tap .
- 2 Select an application, e.g.,  **Weighing**
- 3 Tap .
 - ➔ The screen **Weighing – Main configuration** appears.
- 4 Tap .
 - ➔ The screen **Weighing - reports configuration** appears.
- 5 Tap **Identifications**.
 - ➔ The screen **Identifications** appears.
- 6 Tap **ID 4**.
- 7 Activate **ID 4**.
- 8 Select **Input prompt** and confirm with ✓.
- 9 Tap ✓ to return to the previous screen.
- 10 Place the sample on the weighing pan.
- 11 Tap .
 - ➔ The screen **Sample ID** appears.
- 12 Scan the sample ID with the barcode reader.
 - ➔ The sample ID is entered on the **Sample ID** screen and the screen is then closed.

8.9 Connect a USB keyboard







Use a USB keyboard with US, German and French layout (QWERTY, QWERTZ, AZERTY). An external keyboard can be used to enter the IDs. IDs can consist of numeric, alphanumeric and special characters.

- USB keyboard is connected to the balance.
- 1 Tap  in the status information field on the balance screen.
 - ➔ The screen **Notifications** appears.
- 2 Tap **External input device connected**.
 - ➔ The screen **External input device connected** appears.
- 3 Tap  **Keyboard** and confirm with ✓.
- 4 Tap  to return to the previous screen.
- 5 Tap .
- 6 Tap  **General configuration and data**.
- 7 Tap  **Devices and services**.
 - ➔ The screen **Devices and services** appears.
- 8 Tap  **Keyboard**.
 - ➔ The screen **Keyboard – External input device** appears.
- 9 Tap **Keyboard**.
 - ➔ The screen **Keyboard language** appears.
- 10 Select your language by tapping and confirm with ✓.
- 11 Tap ✓ to confirm.
- 12 Tap  to return to the previous screen.
 - ➔ The IDs can be entered via the external keyboard.

8.10 Export measurement results to a USB memory stick

Connect a USB memory stick (FAT32 formatted, high quality, if possible empty) to the USB host interface.

The USB memory stick appears automatically as a new device in the Menu > **General configuration and data** > **Devices and services**.

- 1 Tap .
- 2 Tap  **General configuration and data**.
- 3 Tap  **Devices and services**.
 - ➔ The screen **Devices and services** appears.
- 4 Tap  **Publishing**.
 - ➔ The screen **Publishing** appears.
- 5 Tap **Print and export report**.
 - ➔ The screen **Print and export – General configuration** appears.
- 6 Tap  **Single values reports**.
 - ➔ The screen **Single values reports** appears.
- 7 Select the transmission mode, e.g., **Automatic, stable** and confirm with ✓.
- 8 Tap ✓ to confirm.
- 9 Tap .
 - ➔ The screen **Export report file** appears.
- 10 Tap **File type**
 - ➔ The screen **File type** appears.
- 11 Select, e.g., **pdf** and confirm with ✓.
- 12 Tap **File name**.
 - ➔ The screen **File name** appears.
- 13 If necessary, change the default name and confirm with ✓.
 - ➔ The screen **Date/Time of file creation** appears.
- 14 Select the **Date/Time of file creation** at the end or beginning of the report and confirm with ✓.
- 15 Tap **File location**.
 - ➔ The screen **File location** appears.
- 16 Enter a name for the path of the storage folder and confirm with ✓.
- 17 Tap ✓ to confirm.
 - ➔ The screen **Publishing** appears.
- 18 Tap ✓ to confirm.
- 19 Tap  to return to the application screen.













View exported data



- 1 Connect memory stick to PC.
- 2 Open the METTLER TOLEDO folder and then the "Reports folder".
- 3 Open the PDF with your relevant measurement results.

8.11 Export XML files to a FTP server and import them with the help of a XSD file

Exporting comprehensive weighing data on a regular basis to an Excel spreadsheet can be done in a very convenient way by exporting/importing the data as an XML file in combination with the use of a XSD file. The XSD file contains the data structure of an XML document, which allows easy integration of weighing results into an Excel sheet. It maps the elements and attributes from the XML file to your Excel spreadsheet/template.

- The balance is connected with an Ethernet cable to the LAN.











- 1 Tap .
 - 2 Tap  **General configuration and data**.
 - 3 Tap  **Network and Bluetooth**.
 - ➔ The screen **Network and Bluetooth** appears.
 - 4 Tap  **LAN**.
 - ➔ The screen **LAN** appears.
 - 5 Tap **ON** to activate **LAN** and confirm with ✓.
 - ➔ LAN connection is established.
 - 6 Tap  to return to the **General configuration and data** screen.
 - 7 Tap  **Devices and services**.
 - ➔ The screen **Devices and services** appears.
 - 8 Tap .
 - ➔ The screen **Device/service type** appears.
 - 9 Tap **File server (FTP)** and confirm with ✓.
 - ➔ The screen **Connection type** appears.
 - 10 Tap **Network: LAN** and confirm with ✓.
 - ➔ The screen **Add Network device – IP address** appears.
 - 11 Enter the IP address of the FTP server and confirm with ✓.
 - ➔ The screen **Add Network device – Port** appears.
 - 12 If necessary, change the port number and confirm with ✓.
 - ➔ The screen **Credentials** appears.
 - 13 If necessary tap **Credentials** and activate the option by tapping **ON**.
 - 14 Enter a user name and password and confirm with ✓.
 - ➔ The screen **File server (FTP) – Remote storage** appears.
 - 15 Tap ✓ to confirm.
 - 16 Tap  to return to the previous screen.
 - 17 Tap  **Publishing**.
 - ➔ The screen **Publishing** appears.
 - 18 Tap **Print and export report**.
 - ➔ The screen **Print and export – General configuration** appears.
 - 19 Tap .
 - ➔ The screen **Export report file** appears.
 - 20 Tap **File type**
 - ➔ The screen **File type** appears.
 - 21 If necessary, change the other settings and confirm with ✓.
 - 22 Select **xml** and confirm with ✓.
 - 23 Tap ✓ to confirm.
 - 24 Tap  to return to the previous screen.
- Make sure that in the application used, the report content is correctly configured.
- 1 Tap .

- ➔ The screen  **Activities - Weighing and other applications** appears.
 - 2 Select, e.g., **% Percent weighing**.
 - 3 Tap  symbol in the upper left corner to define the application.
 - ➔ The screen **Percent weighing – Main configuration** appears.
 - 4 Tap .
 - ➔ The screen **Percent weighing – Reports configuration** appears.
 - 5 Configure the report and conform all you settings with ✓.
 - Download the relevant XSD file for Advanced level balances from www.mt.com/labweighing-software-download.
 - Import the XSD file into MS Excel via the developer tab.
 - Drag and drop the relevant elements and attributes to your Excel spreadsheet.
 - Import the XML weighing report you published on the balance from the FTP server.
 - The Excel spread sheet gets populated with the required data at the pre-defined place.
- For more information on how to use XSD and XML files with MS Excel, please consult the internet.

8.12 Communication with MT-SICS commands via LAN

To enable you to integrate balances in your IT or data management system in a simple manner most balance functions are also available as appropriate commands (MT-SICS) via the data interfaces. The complete set of available commands are available in the "Reference Manual for MT-SICS commands", which can be found in the expertise library www.mt.com/library.

To communicate with MT-SICS commands with the balance over, e.g., LAN the following configuration is required on the balance.

- The balance is connected with an Ethernet cable to the LAN.
- 1 Tap .
- 2 Tap  **General configuration and data**.
- 3 Tap  **Network and Bluetooth**.
 - ➔ The screen **Network and Bluetooth** appears.
- 4 Tap  **LAN**.
 - ➔ The screen **LAN** appears.
- 5 Tap **ON** to activate **LAN** and confirm with ✓.
 - ➔ LAN connection is established.
- 6 Tap  to return to the **General configuration and data** screen.
- 7 Tap  **Devices and services**.
 - ➔ The screen **Devices and services** appears.
- 8 Tap .
- ➔ The screen **Device/service type** appears.
- 9 Select **Command host** and confirm with ✓.
 - ➔ The screen **Connection type** appears.
- 10 Tap **Network: LAN** and confirm with ✓.
 - ➔ The screen **Add Network service – Port** appears.
- 11 If necessary, change the port number and confirm with ✓.
 - ➔ The screen **Command host – Hosting system** appears.
- 12 Configure the **Command set**, **Character set** and **End of line** according your requirements and confirm with ✓.
- 13 Tap ✓ to confirm.
- 14 Tap  to return to the **General configuration and data** screen.
- 15 Tap  **Publishing**.
 - ➔ The screen **Publishing** appears.
- 16 Tap **Send data**.
 - ➔ The screen **Send data** appears.
- 17 Select the transmission mode to use when no MT-SICS command is sent from the system and confirm with ✓.
- 18 Tap ✓ to confirm.
- 19 Tap  to return to the previous screen.
 - ➔ The balance is ready to respond on MT-SICS commands via the LAN interface.

9 Maintenance

To guarantee the functionality of the balance and the accuracy of the weighing results, a number of maintenance actions must be performed by the user.

9.1 Maintenance tasks

Maintenance action	Recommended interval	Remarks
Performing an internal adjustment	<ul style="list-style-type: none">• Daily• After cleaning• After leveling• After changing the location	see "Activities - Adjustments and tests"
Performing routine tests (eccentricity test, repeatability test, sensitivity test). METTLER TOLEDO recommends to at least perform a sensitivity test.	<ul style="list-style-type: none">• After cleaning• After assembling the balance• Depending on your internal regulations (SOP)	see "Activities - Adjustments and tests"
Cleaning	<ul style="list-style-type: none">• After every use• After changing the substance• Depending on the degree of pollution• Depending on your internal regulations (SOP)	see "Cleaning"

See also

 Activities - Adjustments and tests ▶ Page 95

 Cleaning ▶ Page 116

9.2 Cleaning

9.2.1 Cleaning the glass draft shield (0.1 mg and 1 mg models)



CAUTION

Injury due to sharp objects or broken glass

Instrument components, e.g., glass, can break and lead to injuries.

– Always proceed with focus and care.

- 1 Remove weighing pan, draft shield element and pan support.
- 2 Remove the bottom plate.
- 3 Unlock the draft shield, lift it off the balance and place it on a clean surface.

- 4 Push the glass doors (1) back.
- 5 Turn the two lock covers (2) on the front as far as they will go.

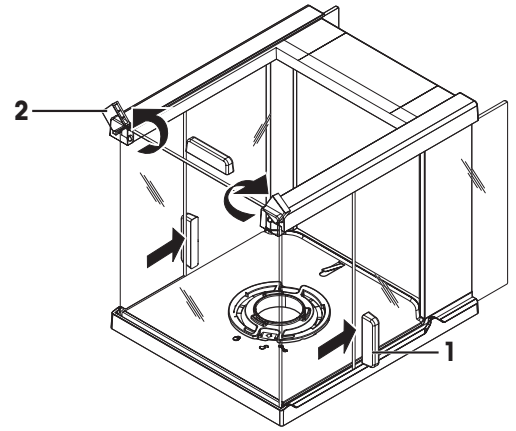

- 6 Tilt the front glass (3) forward.
- 7 Remove the front glass.

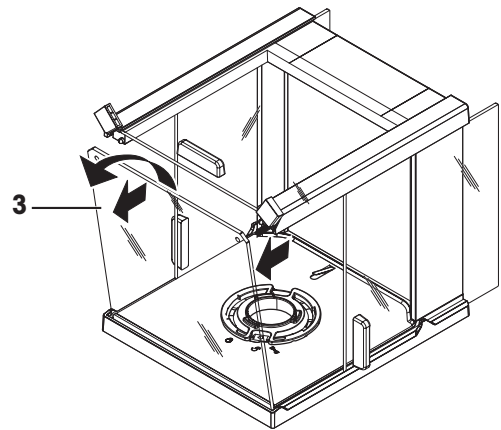

- 8 Pull the top glass door (4) out from the front.

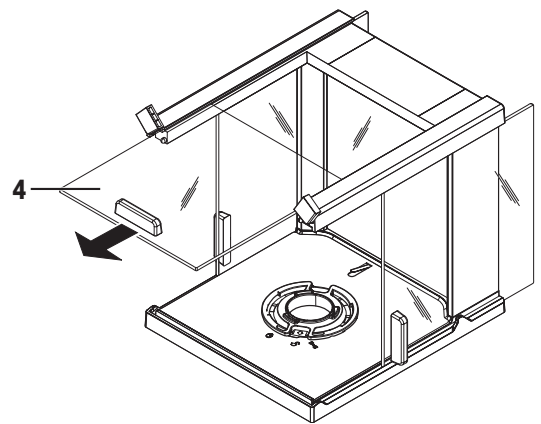

- 9 Lift the side glass doors (5) and (6) and pull them out from the front.

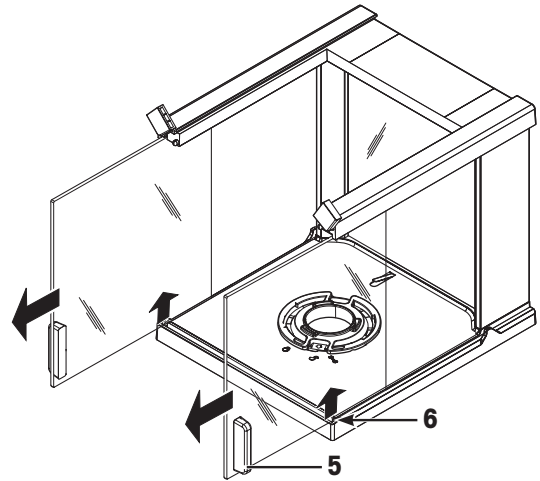

- 10 Push the lock button (7) to release the rear glass.

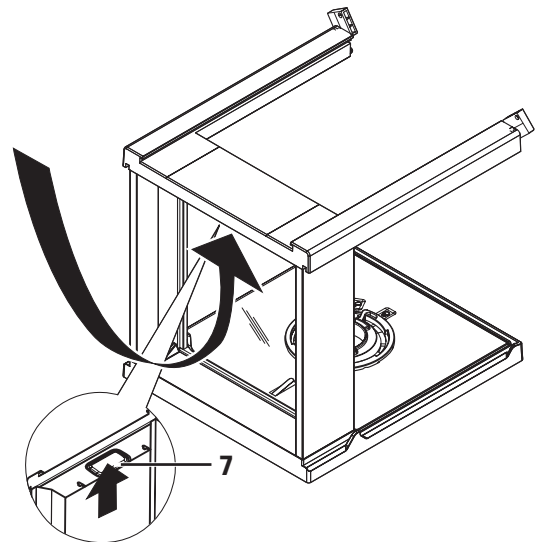

- 11 Remove the rear glass (8).

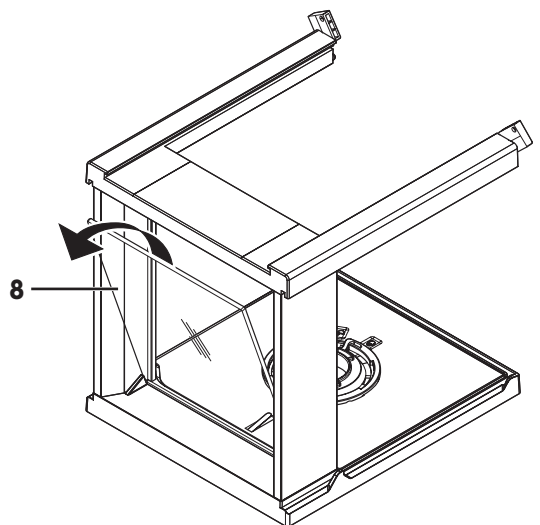

12 Turn the draft shield lock to the  (Service) position.

13 Remove the draft shield lock.

After cleaning, reinstall all components in the reverse order. For balance mounting, refer to "Assembling the balance".

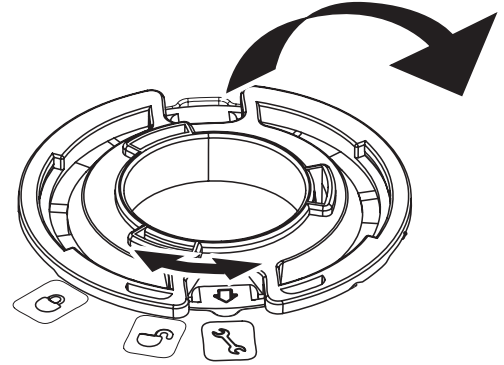

9.2.2 Cleaning the balance



WARNING

Death or serious injury due to electric shock

Contact with parts carrying a live current can lead to injury and death.

- 1 Disconnect the instrument from the power supply prior to cleaning and maintenance.
- 2 Prevent liquid from entering the instrument, terminal or AC/DC adapter.



NOTICE

Damage due to improper cleaning

Improper cleaning can damage the load cell or other essential parts.

- 1 Do not use any cleaning agents other than the ones specified in the "Reference Manual" or "Cleaning Guide".
- 2 Do not spray or pour liquids on the instrument. Always use a moistened lint-free cloth or a tissue.
- 3 Always wipe out from inside to outside of the instrument.

Cleaning around the balance

- Remove any dirt or dust around the balance and avoid further contaminations.

Cleaning the removable parts

- Clean the removed part with a damp cloth or a tissue and a mild cleaning agent.

Cleaning the balance

- 1 Disconnect the balance from the AC/DC adapter.
- 2 Use a lint-free cloth moistened with a mild cleaning agent to clean the surface of the balance.
- 3 Remove powder or dust at first with a disposable tissue.
- 4 Remove sticky substances with a damp lint-free cloth and a mild solvent.



Note



Useful details to avoid soiling the instrument are described in the Mettler-Toledo GmbH "SOP for Cleaning a Balance".

9.2.3 Putting into operation after cleaning

- 1 Reassemble the balance.
- 2 Check the functionality of the draft shield if applicable.
- 3 Press  to switch on the balance.
- 4 Warm up the balance. Wait 1h for the acclimatization, before starting the tests.

- 5 Check the level status, level the balance if necessary.
- 6 Perform an adjustment (internal or external).
- 7 Perform a routine test due to the internal regulations of your company. METTLER TOLEDO recommends to perform a repeatability test after cleaning the balance.
- 8 Press **→0/T←** to zero the balance.
 - ➔ The balance has been put into operation and is ready to use.

See also

-  Leveling the balance ▶ Page 24
-  Activities - Adjustments and tests ▶ Page 95

10 Troubleshooting

Possible errors with their cause and remedy are described in the following chapter. If there are errors that cannot be corrected through these instructions, contact METTLER TOLEDO.

10.1 Error messages

Error message	Possible cause	Diagnostic	Remedy
NO STABILTY	Vibrations at the workplace.	Place beaker with tap water on the weighing table. Vibrations cause ripples on the water surface.	<ul style="list-style-type: none"> Protect weighing location against vibrations (vibration absorber, etc.). Set weighing parameters coarser (change Environment from Stable to Standard or even Unstable). Find a different weighing location (by agreement with customer).
	Draft due to untight draft shield and /or open window.	Make sure draft shield or window is closed.	<ul style="list-style-type: none"> Close draft shield or window. Set weighing parameters coarser (change Environment from Stable to Standard or even Unstable).
	The location is not suitable for weighing.	–	Check and observe the requirements for the location, refer to "Selecting the location".
	Something is touching the weighing pan.	Check for touching parts or dirt.	Remove touching parts or clean the balance.
Adjustment aborted Weight out of range.	Wrong adjustment weight.	Check weight.	Place correct weight on the weighing pan.
EEPROM error.	Data in EEPROM damaged.	–	Please contact your METTLER TOLEDO-Support representative.
Wrong cell data.	Defect load cell data.	–	Please contact your METTLER TOLEDO-Support representative.
No standard adjustment.	–	–	Please contact your METTLER TOLEDO-Support representative.
Program memory defect.	–	–	Please contact your METTLER TOLEDO-Support representative.

Error message	Possible cause	Diagnostic	Remedy
Temperature sensor defect.	AC/DC adapter connected to power before connecting to the balance. Temperature sensor of load cell defect.	–	Remove the AC/DC adapter from the power and connect first to the balance before connecting to the power if persist please contact your METTLER TOLEDO-Support representative.
Wrong load cell brand.	Wrong load cell installed.	–	Please contact your METTLER TOLEDO-Support representative.
Wrong type data set.	Wrong type data set.	–	Please contact your METTLER TOLEDO-Support representative.
Memory full	Memory full.	–	Clear the memory by finishing all applications where a measurement is ongoing.
A problem occurred while starting the balance. Some data could not be read correctly from memory. Please proceed and check date and time settings. Please contact your MT-Support representative if the problem persists.	Some data could not be read correctly from memory.	Check date and time settings.	Please contact your METTLER TOLEDO-Support representative if the problem persists.
A problem occurred while starting the balance. Some data could not be read correctly from memory. The instrument will reset and restart. Please contact your MT-Support representative if the problem persists.	Some data could not be read correctly from memory.	–	Please contact your METTLER TOLEDO-Support representative.
Weight out of initial zero range	Wrong weighing pan. Pan is missing. Pan is not empty.	Check weighing pan.	Mount correct weighing pan or unload weighing pan.
Weight out of zero range	Zero range limit overrun or underrun.	–	Reduce / increase weight on weighing pan.
Weight out of tare range	Tare range limit overrun or underrun.	–	Reduce / increase weight on weighing pan.
Battery backup lost	Backup battery is empty. This battery ensures that the date and time are not lost when the balance is disconnected from power.	Connect the balance to the power supply for charging the battery (full capacity after 2 days of charging).	If battery cannot be recharged, contact your METTLER TOLEDO-Support representative.

Error message	Possible cause	Diagnostic	Remedy
USB device is not recognized when connected to balance	Fluctuation in the external electric grid. Interference from power line.	–	Restart balance.

10.2 Error symptoms









Error symptom	Possible cause	Diagnostic	Remedy
Display is dark	Instrument is switched off.	–	Switch on the instrument.
	Power plug not connected.	Check	Connect power cable to power supply.
	Power supply not connected to balance.	Check	Connect power supply.
	Power supply is faulty.	Check/test	Replace power supply.
	Wrong power supply.	Check that input data on type plate match the power supply values.	Use proper power supply.
	Balance must be restarted.	–	Restart balance.
	Connector socket on balance is corroded or faulty.	Check	Please contact your METTLER TOLEDO-Support representative.
Touch display is not responding	Display is faulty.	Replace display.	Please contact your METTLER TOLEDO-Support representative.
	Touch display is faulty.	Replace display.	Please contact your METTLER TOLEDO-Support representative.
Touch display is partly not responding	Touch display is not correctly adjusted.	–	Perform touch screen adjustment. Reset balance (factory reset).
The value drifts into plus or minus	Room, environment not suitable.	–	Environmental recommendations <ul style="list-style-type: none"> • Windowless, non air-conditioned room, e.g., basement. • Only one person in the weighing room. • Sliding doors. Standard doors cause pressure changes. • No draft in weighing room (check with suspended threads). • No air conditioning (temperature oscillates, draft). • Acclimatize balance, take dummy measurements.





Error symptom	Possible cause	Diagnostic	Remedy
			<ul style="list-style-type: none"> Instrument uninterruptedly connected to the power supply (24h per day).
	Direct sunlight or other heat source.	Is any sun shade (blinds, curtains, etc.) available?	Select location according to "Selecting the location" (customer responsibility).
	Weighing sample absorbs moisture or evaporates moisture.	<ul style="list-style-type: none"> Is the weighing result with a test weight stable? Sensitive weighing samples, e.g., paper, cardboard, wood, plastic, rubber, liquids. 	<ul style="list-style-type: none"> Use aids. Cover weighing sample.
	Weighing sample is electrostatically charged.	<ul style="list-style-type: none"> Is the weighing result with a test weight stable? Sensitive weighing samples, e.g., plastic, powder, insulating materials. 	<ul style="list-style-type: none"> Increase air humidity in weighing chamber (45% - 50%). Use ionizer.
	Weighing sample is hotter or colder than the air in the weighing chamber.	Weighing operation with test weight does not show this effect.	Bring weighing sample to room temperature before weighing.
	Instrument has not yet reached thermal equilibrium.	<ul style="list-style-type: none"> Was there a power outage? Was power supply disconnected? 	<ul style="list-style-type: none"> Acclimatize instrument for at least 1 hour. Depending on climatic conditions, extend this period accordingly. Instrument switched on for at least 1 hour, refer to "General data"
Display shows overload or underload	The weight on the weighing pan exceeds the weighing capacity of the instrument.	Check weight.	Reduce the weight on the weighing pan.
	Wrong weighing pan.	Slightly lift or press weighing pan. The weight display appears.	Use proper weighing pan.
	No weighing pan.	–	Install weighing pan.
	Incorrect zero point at switch-on.	–	<ul style="list-style-type: none"> Switch off balance. Disconnect and reconnect power cable.

10.3 Status messages/Status icons

Status messages are displayed by means of small icons. The status icons indicate the following:

Icon	Status description	Diagnostic	Remedy
	Automatic FACT adjustment is currently not possible.	Instrument is busy.	<ul style="list-style-type: none"> Unload the balance. Do not press any key for 2 minutes. The display stabilizes.

Icon	Status description	Diagnostic	Remedy
	Service due.	–	Please contact your METTLER TOLEDO-Support representative.
	The built-in level sensor has detected that the instrument is not correctly leveled.	Instrument is out of level.	Immediately level the instrument.
	LAN connected.	Settings can be modified.	Tap icon in the status field. <ul style="list-style-type: none"> View corresponding settings. Link to corresponding settings in Network and Bluetooth area by means of "edit" function.
	LAN cable disconnected.	Check cable.	Connect the cable.
	LAN connection problem.	Settings can be modified.	Tap icon in the status field. <ul style="list-style-type: none"> View corresponding settings. Link to corresponding settings in Network and Bluetooth area by means of "edit" function.
	WLAN not connected.	Network not selected.	Select network.
		Settings can be modified.	Tap icon in the status field. <ul style="list-style-type: none"> View corresponding settings. Link to corresponding settings in Network and Bluetooth area by means of "edit" function.
	WLAN connected. Three bars are indicating signal strength of connection.	Settings can be modified.	Tap icon in the status field. <ul style="list-style-type: none"> View corresponding settings. Link to corresponding settings in Network and Bluetooth area by means of "edit" function.
	WLAN secured connected. Three bars are indicating signal strength of connection.	Settings can be modified.	Tap icon in the status field. <ul style="list-style-type: none"> View corresponding settings. Link to corresponding settings in Network and Bluetooth area by means of "edit" function.
	WLAN connection problem.	Settings can be modified.	Tap icon in the status field. <ul style="list-style-type: none"> View corresponding settings. Link to corresponding settings in Network and Bluetooth area by means of "edit" function.
	Bluetooth ON.	Bluetooth function active, set as ON in settings. Settings can be modified.	Tap icon in the status field. <ul style="list-style-type: none"> View corresponding settings. Link to corresponding settings in Network and Bluetooth area by means of "edit" function.

Icon	Status description	Diagnostic	Remedy
	Bluetooth not available.	Bluetooth function active (set as ON in settings) but needs dongle reset.	Tap icon in the status field, reset dongle.
		Settings can be modified.	Tap icon in the status field. <ul style="list-style-type: none"> View corresponding settings. Link to corresponding settings in Network and Bluetooth area by means of "edit" function.
	Bluetooth not connected.	The external device has been paired but it's not connected, or the balance has been disconnected on the other device. Settings can be modified.	Check connection on external device.
	Bluetooth problem.	Bluetooth device is not in range or the connection has failed. Settings can be modified.	Check the device and/or connection. <ul style="list-style-type: none"> View corresponding settings. Link to corresponding settings in Network and Bluetooth area by means of "edit" function.
	Connection request.	An external Bluetooth device wants to connect with balance.	Tap icon in the status field. <ul style="list-style-type: none"> View corresponding workflow. Connect external device and select the device type in Devices and services.
	Connection request failed.	Connection with external Bluetooth device failed.	Tap icon in the status field. <ul style="list-style-type: none"> View corresponding workflow. Connect external device and select the device type in Devices and services.
	External input device connected.	A keyboard or a barcode reader has been connected to the balance, and the balance could not recognize the device type.	Tap icon in the status field. <ul style="list-style-type: none"> View corresponding workflow. Connect external device and select the device type in Devices and services.
	Publishing failed	One or more publishing processes have failed.	Tap icon in the status field. View corresponding message(s). Fails are recorded in the ISO-Log.

10.4 Putting into operation after fixing an error

After fixing an error, perform the following steps to put the balance into operation:

- Ensure that the balance is completely reassembled and cleaned.
- Reconnect the balance to the AC/DC adapter.

11 Technical Data

11.1 General data

Standard power supply

AC/DC adapter:

Input: 100 – 240 V AC \pm 10%, 50 – 60 Hz, 0.5 A, 24 – 34 VA

Output: 12 V DC, 1.0 A, LPS (Limited Power Source)

Polarity:



Balance power consumption:

12 V DC, 0.6 A

Mean sea level:

Can be used up to 2000 m above mean sea level

If the balance is used above 2000 m mean sea level, the optional power supply must be used.

Power supply for 0.1 mg models

For 0.1 mg models the optional power supply is used as standard power supply.

Optional power supply

AC/DC adapter:

Input: 100 – 240 V AC \pm 10%, 50 – 60 Hz, 0.8 A, 60 – 80 VA

Output: 12 V DC, 2.5 A, LPS (Limited Power Source)

Cable for AC/DC adapter:

3-core, with country-specific plug

Polarity:



Mean sea level:

Can be used up to 4000 m above mean sea level

Protection and standards

Overvoltage category:

II

Degree of pollution:

2

Protection:

Protected against dust and water

Standards for safety and EMC:

See Declaration of Conformity

Range of application:

Use only indoors in dry locations

Environmental conditions

Height above mean sea level:

Up to 2000 m (standard power supply)

Up to 4000 m (optional power supply)

Ambient temperature:

Operating conditions for ordinary lab application: +10 °C to +30 °C (operability guaranteed between +5 °C and +40 °C)

Relative air humidity:

Max. 80% up to 31 °C, linearly decreasing to 50% at 40 °C, non-condensing

Warm-up time:

At least 30 minutes (60 minutes for 0.1 mg models) after connecting the balance to the power supply. When switched on from standby, the instrument is ready for operation immediately.

Materials

Housing:

Die-cast aluminum

Weighing pan:

Stainless steel X2CrNiMo 17-12-2 (1.4404)

Roughness Ra < 0.8 μ m

Draft shield element:

0.1 mg models: Stainless steel X2CrNiMo 17-12-2 (1.4404)

10 mg models: PBT

Draft shield:

PBT, glass

Protective cover:	PET
TFT touch screen surface:	Glass

11.2 Model-specific data

11.2.1 Analytical balances with a readability of 0.1 mg with draft shield

	MS104TS	MS204TS	MS304TS
Limit values			
Capacity	120 g	220 g	320 g
Nominal load	100 g	200 g	300 g
Readability	0.1 mg	0.1 mg	0.1 mg
Capacity of fine range	–	–	–
Readability in fine range	–	–	–
Repeatability	0.1 mg	0.1 mg	0.1 mg
Repeatability in fine range	–	–	–
Linearity deviation	0.2 mg	0.2 mg	0.2 mg
Eccentricity deviation (at test load)	0.4 mg (50 g)	0.4 mg (100 g)	0.4 mg (100 g)
Sensitivity offset (at nominal load) ¹⁾	1 mg	1.2 mg	2.4 mg
Sensitivity temperature drift ²⁾	0.00015%/°C	0.00015%/°C	0.00015%/°C
Typical values			
Repeatability	0.08 mg	0.08 mg	0.08 mg
Repeatability in fine range	–	–	–
Linearity deviation	0.06 mg	0.06 mg	0.06 mg
Eccentricity deviation (at test load)	0.12 mg (50 g)	0.12 mg (100 g)	0.12 mg (100 g)
Sensitivity offset (at nominal load) ¹⁾	0.6 mg	0.8 mg	1.5 mg
Minimum weight (USP, tolerance = 0.10%) ³⁾	160 mg	160 mg	160 mg
Minimum weight (tolerance = 1%) ³⁾	16 mg	16 mg	16 mg
Settling time	2 s	2 s	3 s
Adjustment	Internal / FACT	Internal / FACT	Internal / FACT
Dimensions & other specifications			
Balance dimensions (WxDxH)	204x347x348 mm	204x347x348 mm	204x347x348 mm
Weighing pan diameter	90 mm	90 mm	90 mm
Usable height of draft shield	236 mm	236 mm	236 mm
Balance weight	5.9 kg	5.9 kg	5.9 kg
Weights for routine testing			
Weights (OIML class)	5 g (F2)/ 100 g (F2)	10 g (F2)/ 200 g (F2)	10 g (F2)/ 200 g (F2)
Weights (ASTM class)	5 g (ASTM 1)/ 100 g (ASTM 1)	10 g (ASTM 1)/ 200 g (ASTM 1)	10 g (ASTM 1)/ 200 g (ASTM 1)

¹⁾ after adjustment with internal weight

²⁾ In the temperature range +10 °C – +30 °C

³⁾ determined at 5% load, k = 2

11.2.2 Precision balances with a readability of 1 mg with draft shield

	MS303TS	MS403TS
Limit values		
Capacity	320 g	420 g
Nominal load	300 g	400 g
Readability	1 mg	1 mg
Capacity of fine range	–	–
Readability in fine range	–	–
Repeatability	1 mg	1 mg
Repeatability in fine range	–	–
Linearity deviation	2 mg	2 mg
Eccentricity deviation (at test load)	4 mg (100 g)	4 mg (200 g)
Sensitivity offset (at nominal load) ¹⁾	8 mg	8 mg
Sensitivity temperature drift ²⁾	0.0003%/°C	0.0003%/°C
Typical values		
Repeatability	0.7 mg	0.7 mg
Repeatability in fine range	–	–
Linearity deviation	0.6 mg	0.6 mg
Eccentricity deviation (at test load)	1.5 mg (100 g)	1.5 mg (200 g)
Sensitivity offset (at nominal load) ¹⁾	5 mg	5 mg
Minimum weight (USP, tolerance = 0.10%) ³⁾	1.4 g	1.4 g
Minimum weight (tolerance = 1%) ³⁾	140 mg	140 mg
Settling time	1.5 s	1.5 s
Adjustment	Internal / FACT	Internal / FACT
Dimensions & other specifications		
Balance dimensions (WxDxH)	204x347x283 mm	204x347x283 mm
Weighing pan dimensions (WxD)	127x127 mm	127x127 mm
Usable height of draft shield	168 mm	168 mm
Balance weight	5.6 kg	5.6 kg
Weights for routine testing		
Weights (OIML class)	10 g (F2)/ 200 g (F2)	20 g (F2)/ 200 g (F2)
Weights (ASTM class)	10 g (ASTM 1)/ 200 g (ASTM 1)	20 g (ASTM 1)/ 200 g (ASTM 1)

¹⁾ after adjustment with internal weight

²⁾ In the temperature range +10 °C – +30 °C

³⁾ determined at 5% load, k = 2

	MS603TS	MS1003TS
Limit values		
Capacity	620 g	1020 g
Nominal load	600	1000 g
Readability	1 mg	1 mg
Capacity of fine range	–	–
Readability in fine range	–	–
Repeatability	1 mg	1 mg
Repeatability in fine range	–	–
Linearity deviation	2 mg	2 mg
Eccentricity deviation (at test load)	4 mg (200 g)	4 mg (500 g)
Sensitivity offset (at nominal load) ¹⁾	8 mg	8 mg
Sensitivity temperature drift ²⁾	0.0003%/°C	0.0003%/°C
Typical values		
Repeatability	0.7 mg	0.7 mg
Repeatability in fine range	–	–
Linearity deviation	0.6 mg	0.6 mg
Eccentricity deviation (at test load)	1.5 mg (200 g)	1.5 mg (500 g)
Sensitivity offset (at nominal load) ¹⁾	5 mg	5 mg
Minimum weight (USP, tolerance = 0.10%) ³⁾	1.4 g	1.4 g
Minimum weight (tolerance = 1%) ³⁾	140 mg	140 mg
Settling time	2 s	2 s
Adjustment	Internal / FACT	Internal / FACT
Dimensions & other specifications		
Balance dimensions (W×D×H)	204×347×283 mm	204×347×283 mm
Weighing pan dimensions (W×D)	127×127 mm	127×127 mm
Usable height of draft shield	168 mm	168 mm
Balance weight	5.6 kg	5.6 kg
Weights for routine testing		
Weights (OIML class)	20 g (F2)/ 500 g (F2)	50 g (F2)/ 1000 g (F2)
Weights (ASTM class)	20 g (ASTM 1)/ 500 g (ASTM 1)	50 g (ASTM 1)/ 1000 g (ASTM 1)

¹⁾ after adjustment with internal weight

²⁾ In the temperature range +10 °C – +30 °C

³⁾ determined at 5% load, k = 2

11.2.3 Precision balances with a readability of 10 mg

	MS1602TS	MS3002TS	MS4002TS
Limit values			
Capacity	1620 g	3.2 kg	4.2 kg
Nominal load	1600 g	3 kg	4 kg
Readability	10 mg	10 mg	10 mg
Capacity of fine range	–	–	–
Readability in fine range	–	–	–
Repeatability	10 mg	10 mg	10 mg
Repeatability in fine range	–	–	–
Linearity deviation	20 mg	20 mg	20 mg
Eccentricity deviation (at test load)	30 mg (500 g)	40 mg (1000 g)	40 mg (2 kg)
Sensitivity offset (at nominal load) ¹⁾	80 mg	80 mg	80 mg
Sensitivity temperature drift ²⁾	0.0003%/°C	0.0003%/°C	0.0003%/°C
Typical values			
Repeatability	7 mg	7 mg	7 mg
Repeatability in fine range	–	–	–
Linearity deviation	6 mg	6 mg	6 mg
Eccentricity deviation (at test load)	10 mg (500 g)	15 mg (1000 g)	15 mg (2 kg)
Sensitivity offset (at nominal load) ¹⁾	50 mg	50 mg	50 mg
Minimum weight (USP, tolerance = 0.10%) ³⁾	14 g	14 g	14 g
Minimum weight (tolerance = 1%) ³⁾	1.4 g	1.4 g	1.4 g
Settling time	1.5 s	1.5 s	1.5 s
Adjustment	Internal / FACT	Internal / FACT	Internal / FACT
Dimensions & other specifications			
Balance dimensions (WxDxH)	194x347x99 mm	194x347x99 mm	194x347x99 mm
Weighing pan dimensions (WxD)	170x200 mm	170x200 mm	170x200 mm
Usable height of draft shield	–	–	–
Balance weight	4.6 kg	4.6 kg	4.6 kg
Weights for routine testing			
Weights (OIML class)	50 g (F2)/ 1000 g (F2)	100 g (F2)/ 2000 g (F2)	200 g (F2)/ 2000 g (F2)
Weights (ASTM class)	50 g (ASTM 1)/ 1000 g (ASTM 1)	100 g (ASTM 1)/ 2000 g (ASTM 1)	200 g (ASTM 4)/ 2000 g (ASTM 4)

¹⁾ after adjustment with internal weight

²⁾ In the temperature range +10 °C – +30 °C

³⁾ determined at 5% load, k = 2

	MS4002TS DR	MS6002TS	MS6002TS DR
Limit values			
Capacity	4.2 kg	6.2 kg	6.2 kg
Nominal load	4 kg	6 kg	6 kg
Readability	100 mg	10 mg	100 mg
Capacity of fine range	820 g	–	1220 g
Readability in fine range	10 mg	–	10 mg
Repeatability	100 mg	10 mg	10 mg
Repeatability in fine range	10 mg	–	10 mg
Linearity deviation	70 mg	20 mg	70 mg
Eccentricity deviation (at test load)	100 mg (2 kg)	60 mg (2 kg)	100 mg (2 kg)
Sensitivity offset (at nominal load) ¹⁾	160 mg	80 mg	160 mg
Sensitivity temperature drift ²⁾	0.0003%/°C	0.0003%/°C	0.0003%/°C
Typical values			
Repeatability	50 mg	7 mg	50 mg
Repeatability in fine range	7 mg	–	7 mg
Linearity deviation	20 mg	6 mg	20 mg
Eccentricity deviation (at test load)	30 mg (2 kg)	20 mg (2 kg)	30 mg (2 kg)
Sensitivity offset (at nominal load) ¹⁾	100 mg	50 mg	100 mg
Minimum weight (USP, tolerance = 0.10%) ³⁾	14 g	14 g	14 g
Minimum weight (tolerance = 1%) ³⁾	1.4 g	1.4 g	1.4 g
Settling time	1.5 s	1.5 s	1.5 s
Adjustment	Internal / FACT	Internal / FACT	Internal / FACT
Dimensions & other specifications			
Balance dimensions (W×D×H)	194×347×99 mm	194×347×99 mm	194×347×99 mm
Weighing pan dimensions (W×D)	170×200 mm	170×200 mm	170×200 mm
Usable height of draft shield	–	–	–
Balance weight	4.6 kg	5.1 kg	5.1 kg
Weights for routine testing			
Weights (OIML class)	200 g (F2)/ 2000 g (F2)	200 g (F2)/ 5000 g (F2)	200 g (F2)/ 5000 g (F2)
Weights (ASTM class)	200 g (ASTM 4)/ 2000 g (ASTM 4)	200 g (ASTM 4)/ 5000 g (ASTM 4)	200 g (ASTM 4)/ 5000 g (ASTM 4)

¹⁾ after adjustment with internal weight

²⁾ In the temperature range +10 °C – +30 °C

³⁾ determined at 5% load, k = 2

MS12002TS	
Limit values	
Capacity	12.2 kg
Nominal load	12 kg
Readability	10 mg
Capacity of fine range	–
Readability in fine range	–
Repeatability	10 mg
Repeatability in fine range	–
Linearity deviation	20 mg
Eccentricity deviation (at test load)	70 mg (5 kg)
Sensitivity offset (at nominal load) ¹⁾	80 mg
Sensitivity temperature drift ²⁾	0.0003%/°C
Typical values	
Repeatability	7 mg
Repeatability in fine range	–
Linearity deviation	6 mg
Eccentricity deviation (at test load)	25 mg (5 kg)
Sensitivity offset (at nominal load) ¹⁾	50 mg
Minimum weight (USP, tolerance = 0.10%) ³⁾	14 g
Minimum weight (tolerance = 1%) ³⁾	1.4 g
Settling time	1.5 s
Adjustment	Internal / FACT
Dimensions & other specifications	
Balance dimensions (WxDxH)	194x347x99 mm
Weighing pan dimensions (WxD)	170x200 mm
Usable height of draft shield	–
Balance weight	5.2 kg
Weights for routine testing	
Weights (OIML class)	500 g (F2)/ 10000 g (F2)
Weights (ASTM class)	500 g (ASTM 4)/ 10000 g (ASTM 4)

¹⁾ after adjustment with internal weight

²⁾ In the temperature range +10 °C – +30 °C

³⁾ determined at 5% load, k = 2

11.2.4 Precision balances with a readability of 100 mg

MS8001TS	
Limit values	
Capacity	8.2 kg
Nominal load	8 kg
Readability	100 mg
Capacity of fine range	–
Readability in fine range	–
Repeatability	100 mg
Repeatability in fine range	–
Linearity deviation	200 mg
Eccentricity deviation (at test load)	500 mg (5 kg)
Sensitivity offset (at nominal load) ¹⁾	600 mg
Sensitivity temperature drift ²⁾	0.0005%/°C
Typical values	
Repeatability	70 mg
Repeatability in fine range	–
Linearity deviation	60 mg
Eccentricity deviation (at test load)	150 mg (5 kg)
Sensitivity offset (at nominal load) ¹⁾	400 mg
Minimum weight (USP, tolerance = 0.10%) ³⁾	140 g
Minimum weight (tolerance = 1%) ³⁾	14 g
Settling time	1 s
Adjustment	Internal / FACT
Dimensions & other specifications	
Balance dimensions (WxDxH)	194x347x99 mm
Weighing pan dimensions (WxD)	190x226 mm
Usable height of draft shield	–
Balance weight	4.6 kg
Weights for routine testing	
Weights (OIML Class)	200 g (F2)/ 5000 g (F2)
Weights (ASTM Class)	200 g (ASTM 4)/ 5000 g (ASTM 4)

¹⁾ after adjustment with internal weight

²⁾ In the temperature range +10 °C – +30 °C

³⁾ determined at 5% load, k = 2

11.3 Dimensions

11.3.1 Balances with a readability of 0.1 mg with draft shield

Models:

MS104TS

MS204TS

MS304TS

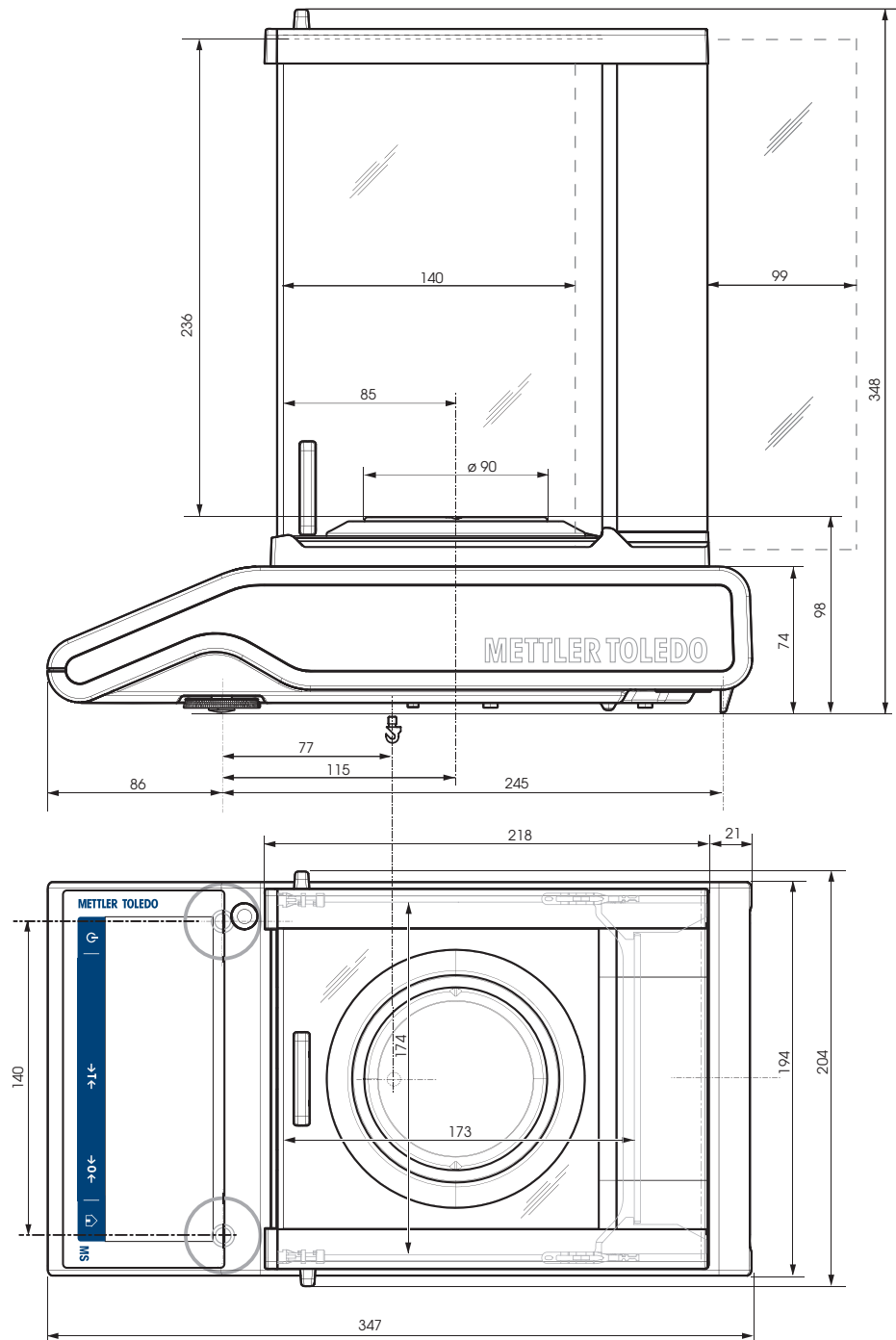

11.3.2 Balances with a readability of 1 mg with draft shield

Models:

- MS303TS
- MS403TS
- MS603TS
- MS1003TS

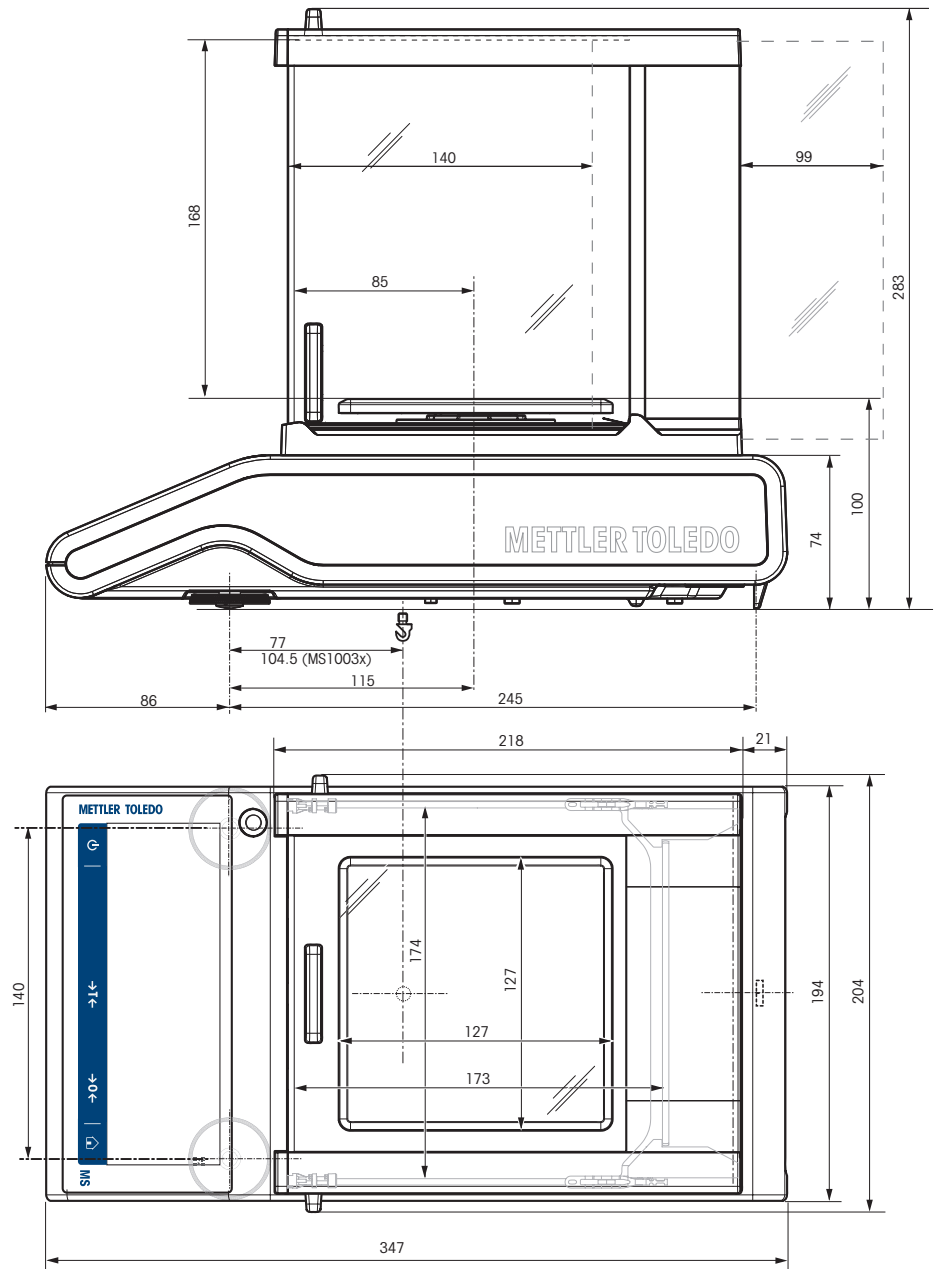

11.3.3 Balances with a readability of 10 mg

Models:

- MS1602TS
- MS3002TS
- MS4002TS
- MS4002TS DR
- MS6002TS
- MS6002TS DR
- MS12002TS

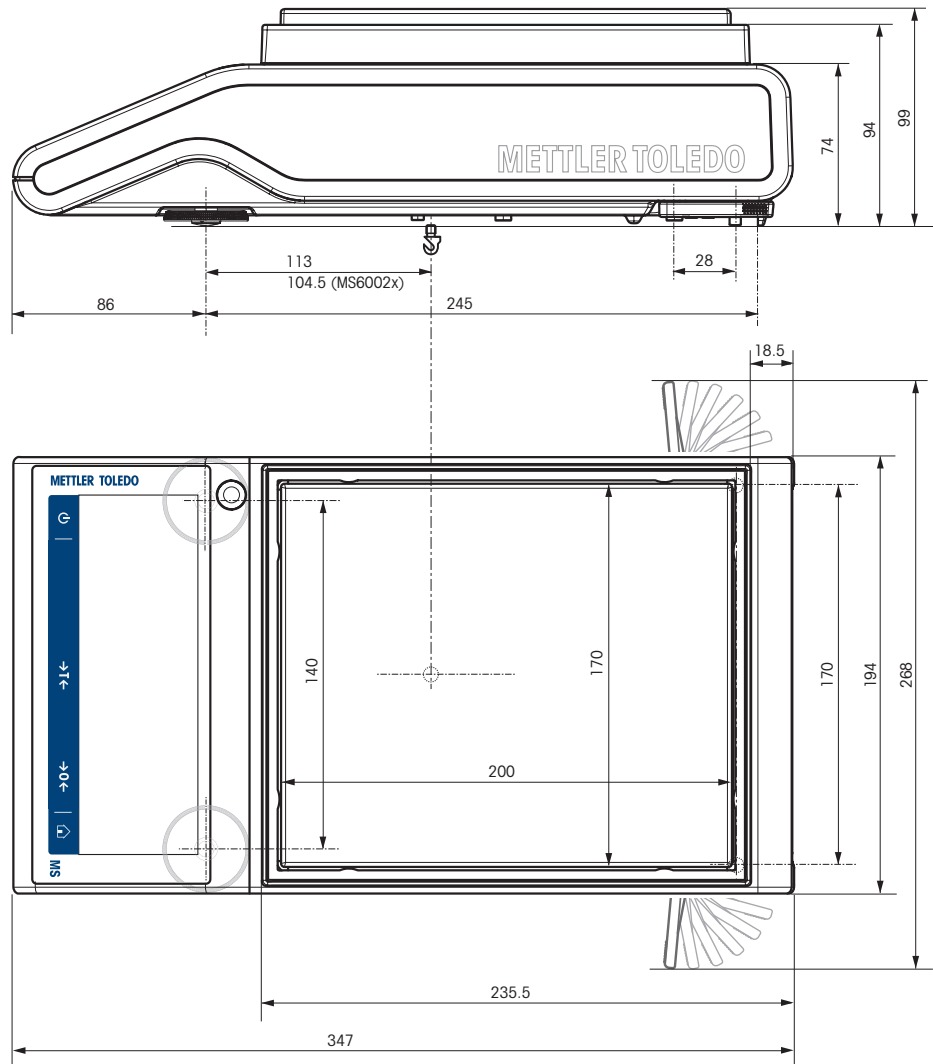

11.3.4 Balances with a readability of 100 mg

Models:
MS8001TS

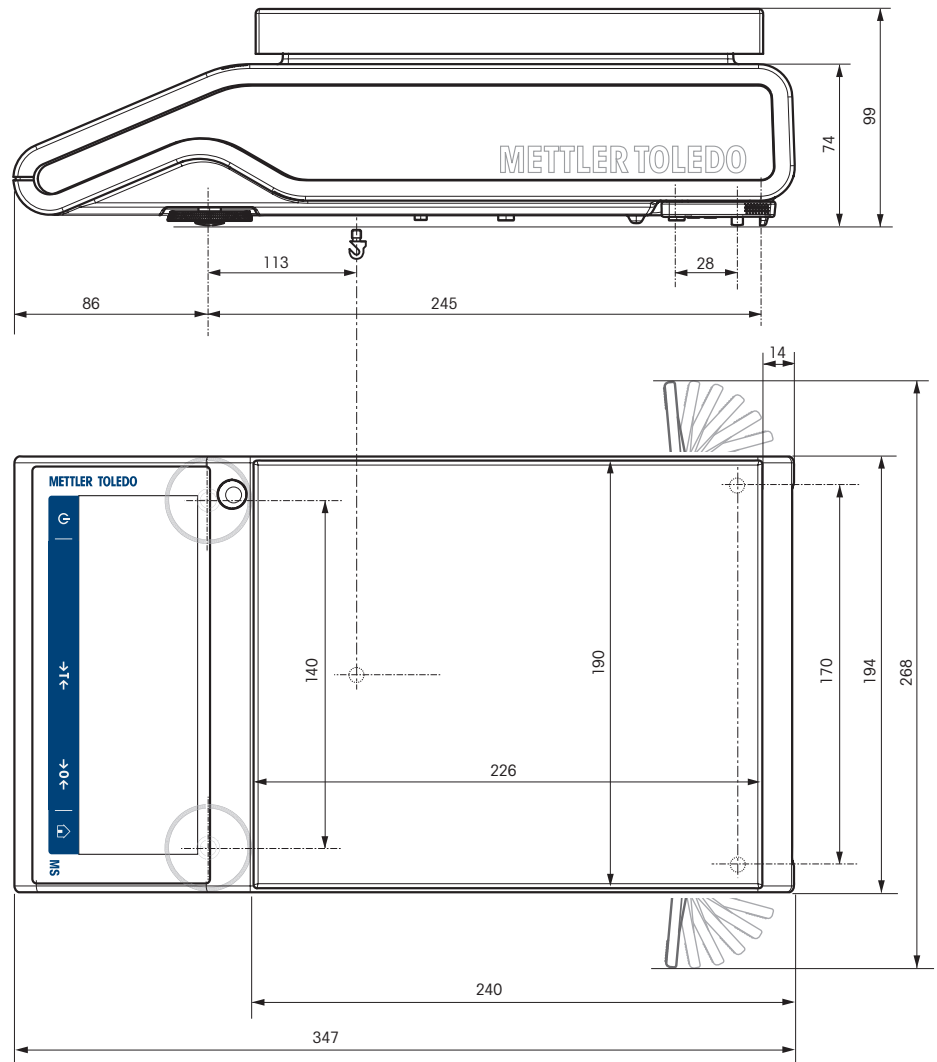

11.4 Interface specifications

11.4.1 RS232C interface

Each balance is equipped with a RS232C Interface as standard for the attachment of a peripheral device, e.g., a printer or a computer.

Schematic	Item	Specification
	Interface type	Voltage interface according to EIA RS232C/ DIN66020 CCITT V24/V.28)
	Max. cable length	15 m
	Signal level	Outputs: +5 V ... +15 V (RL = 3–7 kΩ) –5 V ... –15 V (RL = 3–7 kΩ) Inputs: +3 V ... +25 V –3 V ... –25 V
	Connector	Sub-D, 9-pole, female
	Operating mode	Full duplex
	Transmission mode	Bit-serial, asynchronous
	Transmission code	ASCII
	Baud rates	600, 1200, 2400, 4800, 9600, 19200, 38400 (software selectable)
	Bits/parity	7-bit/none, 7-bit/even, 7-bit/odd, 8-bit/none (software selectable)
	Stop bits	1 stop bit
	Handshake	None, XON/XOFF, RTS/CTS (software selectable)
	End-of-line	<CR><LF>, <CR>, <LF> (software selectable)
	Power supply for 2nd display	+ 12 V, max 40 mA (software selectable, 2nd display mode only)

11.4.2 USB host

Each balance is equipped with a USB host as standard for the attachment of a peripheral device, e.g., printer, barcode reader.

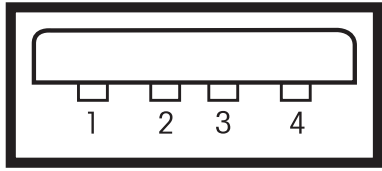
Schematic	Item	Specification	
	Standard	In conformity with USB specifications revision 2.0	
	Speed	Full-speed 12 Mbps (requires shielded cable)	
	Power usage	Max. 500 mA	
	Connector	Type A	
	Pin assignment	1	VBUS (+5 V DC)
		2	D- (Data -)
		3	D+ (Data +)
4		GND (Ground)	
Shell	Shield		

11.4.3 USB device

Each balance is equipped with a USB device interface as standard for the attachment of a peripheral device, e.g. a computer.



Note

This interface is not able to communicate with a printer.

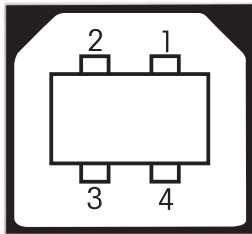
Schematic	Item	Specification										
 <table border="1" data-bbox="395 1272 681 1438"> <tr> <td>1</td> <td>VBUS (+5 VDC)</td> </tr> <tr> <td>2</td> <td>D- (Data -)</td> </tr> <tr> <td>3</td> <td>D+ (Data +)</td> </tr> <tr> <td>4</td> <td>GND (Ground)</td> </tr> <tr> <td>Shield</td> <td>Shield</td> </tr> </table>	1	VBUS (+5 VDC)	2	D- (Data -)	3	D+ (Data +)	4	GND (Ground)	Shield	Shield	Standard	In conformity with USB specifications revision 2.0
	1	VBUS (+5 VDC)										
	2	D- (Data -)										
	3	D+ (Data +)										
	4	GND (Ground)										
Shield	Shield											
Speed	Full-speed 12 Mbps (requires shielded cable)											
Function	CDC (Communication Device Class) serial port emulation											
Power usage	Suspended device: Max 10 mA											
Connector	Type B											

11.4.4 Ethernet

Each balance is equipped with an Ethernet interface as standard to connect to a LAN or a P-50 printer.

Item	Specification
Connection	RJ45
Speed	10/100 Mbps (10BASE-T, 100BASE-TX, Auto MDI-X)
Recommended Ethernet cable	Cat 5
Supported Ethernet standard	IEEE 802.3
Supported network protocols and services	TCP/IP, FTP

11.4.5 Wi-Fi and Bluetooth

There is the optional METTLER TOLEDO wireless dongle (MTICWD-100, part number 30412536) to connect to a WLAN and Bluetooth devices.

Wi-Fi

Item	Specification
Connection	USB 2.0 (bus powered device)
Wi-Fi RF transmission standards	IEEE 802.11 a/b/g/n (2.4 and 5 GHz)
Wi-Fi output power	max. 15 dBm
Supported security protocols	Open / WPA / WPA2 / LEAP / PEAP
Supported network protocols and services	TCP/IP, FTP

Bluetooth

Item	Specification
Connection	USB 2.0 (bus powered device)
Bluetooth transmission standards	BR/EDR v2.1/Low Energy v4.0 (2.4 GHz)
Bluetooth output power	max. 11 dBm
Transmission range	up to 100 m
Supported Bluetooth profiles	SPP (Serial Port Profile)
Supported security modes	BT2.0: fixed-pin BT4.0: Display Yes/No

11.4.6 MT-SICS interface commands and functions

Many of the instruments and balances used have to be able to integrate into a complex computer or data acquisition system.

To easily integrate a balance into a system and utilize its capacity to the full extent, most balance functions are also available as corresponding commands via the data interface.

All new METTLER TOLEDO balances launched on the market support "METTLER TOLEDO Standard Interface Command Set" (MT-SICS). The commands available depend on the functionality of the balance.

For further information, please contact your METTLER TOLEDO representative.



Refer to the MT-SICS Reference Manual.





► www.mt.com/library

12 Accessories and Spare Parts

12.1 Accessories

Accessories are additional components that could help you in your workflow.

	Description	Order no.
Printers		
	RS-P25 printer with RS232C connection to instrument	30702967
	Paper roll (length: 20 m), set of 5 pcs	00072456
	Paper roll (length: 13 m), self-adhesive, set of 3 pcs	11600388
	Ribbon cartridge, black, set of 2 pcs	00065975
	RS-P26/01 (EMEA) printer with RS232C connection to instrument (with date and time)	11124303
	Paper roll (length: 20 m), set of 5 pcs	00072456
	Paper roll, self-adhesive (length: 13 m), set of 3 pcs	11600388
	Ribbon cartridge, black, set of 2 pcs	00065975
	RS-P26/02 (Asia-Pacific) printer with RS232C connection to instrument (with date and time)	11124313
	Paper roll (length: 20 m), set of 5 pcs	00072456
	Paper roll (length: 13 m), self-adhesive, set of 3 pcs	11600388
	Ribbon cartridge, black, set of 2 pcs	00065975
	RS-P26/03 (Northern America) printer with RS232C connection to instrument (with date and time)	11124323
	Paper roll (length: 20 m), set of 5 pcs	00072456
	Paper roll, self-adhesive (length: 13 m), set of 3 pcs	11600388
	Ribbon cartridge, black, set of 2 pcs	00065975
	RS-P28/01 (EMEA) printer with RS232C connection to instrument (with date, time and applications)	11124304
	Paper roll (length: 20 m), set of 5 pcs	00072456
	Paper roll, self-adhesive (length: 13 m), set of 3 pcs	11600388
	Ribbon cartridge, black, set of 2 pcs	00065975
	RS-P28/02 (Asia-Pacific) printer with RS232C connection to instrument (with date, time and applications)	11124314
	Paper roll (length: 20 m), set of 5 pcs	00072456
	Paper roll (length: 13 m), self-adhesive, set of 3 pcs	11600388
	Ribbon cartridge, black, set of 2 pcs	00065975

	RS-P28/03 (Northern America) printer with RS232C connection to instrument (with date, time and applications)	11124324
	Paper roll (length: 20 m), set of 5 pcs	00072456
	Paper roll, self-adhesive (length: 13 m), set of 3 pcs	11600388
	Ribbon cartridge, black, set of 2 pcs	00065975
	USB-P25 printer with USB connection to instrument	30702998
	Paper roll (length: 20 m), set of 5 pcs	00072456
	Paper roll (length: 13 m), self-adhesive, set of 3 pcs	11600388
	Ribbon cartridge, black, set of 2 pcs	00065975
	P-52RUE dot matrix printer RS232C, USB and Ethernet connections, simple print-outs	30237290
	Paper roll (length: 20 m), set of 5 pcs	00072456
	Paper roll (length: 13 m), self-adhesive, set of 3 pcs	11600388
	Ribbon cartridge, black, set of 2 pcs	00065975
	P-56RUE thermal printer with RS232C, USB and Ethernet connections, simple print-outs, date and time	30094673
	Paper roll, white (length: 27 m), set of 10 pcs	30094723
	Paper roll, white, self-adhesive (length: 13 m), set of 10 pcs	30094724
	P-58RUE thermal printer with RS232C, USB and Ethernet connections, simple print-outs, date and time, label printing, balance applications, e.g., statistics, formulation, totaling	30094674
	Paper roll, white (length: 27 m), set of 10 pcs	30094723
	Paper roll, white, self-adhesive (length: 13 m), set of 10 pcs	30094724
	Paper roll, white, self-adhesive labels (550 labels), set of 6 pcs	30094725
	Dimension of the label 56×18 mm	

Cables for RS232C interfaces

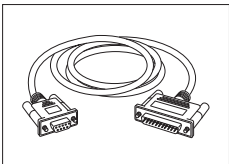
	RS9 connection cable (to connect the instrument to a PC) Length: 1 m	11101051
	RS9 – RS25 (m/f): connection cable for PC, length = 2 m	11101052



USB-RS232 cable (to connect a balance via RS232C to a USB port)

64088427

Cables for USB interface



USB 2.0 High-speed cable to connect balance with PC (USB A to USB B), length = 1 m

30241476

Wireless interfaces



Bluetooth RS232C serial adapter ADP-BT-S

30086494

For wireless connection between:

- instrument and computer (depending on the instrument model)
- printer and instrument



Bluetooth RS232C serial adapter ADP-BT-P, set of 2 pcs

30086495

For wireless connection between:

- Instrument and PC (depending on the instrument model)
- Printer and instrument



Wireless dongle MTICWD-100

30412536

Wireless dongle to connect to a WLAN network and/or via Bluetooth to a P-50RUE Printer or PC/Android Mobile Device (Balance software version 4.10 or higher required).

The wireless dongle is connected to the USB Host interface.

To connect to a P-50 RUE Printer the Bluetooth RS232C serial adapter ADP-BT-S (30086494) needs to be connected to the printer.

Density determination

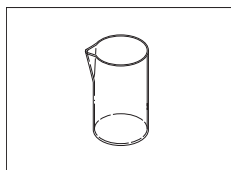

Glass beaker, height 100 mm, \varnothing 60 mm

00238166

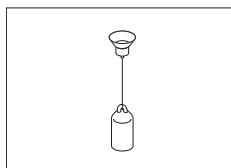

Sinker for density of liquids in conjunction with density kit

00210260

Calibrated (sinker + certificate)

00210672

Recalibrated (new certificate)

00210674

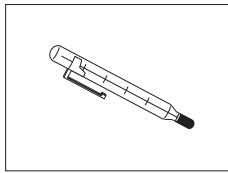

Calibrated thermometer with certificate

11132685



Density Kit Advanced & Standard for balance models with a readability of 0.1 mg / 1 mg

30535760

Weighing pans



Dynamic weighing pan MS-DWP-21 with 4 liter bowl (for balances with a readability of 10 mg and 100 mg)

30006471

Draft shields

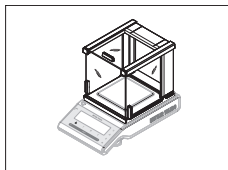

Draft shield with sliding doors "1 mg" (usable height 168 mm)

12122405

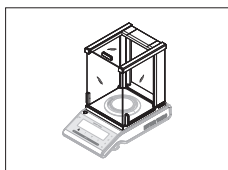

Draft shield with sliding doors "0.1 mg" (usable height 236 mm)

12122404

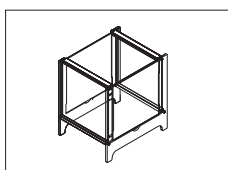

Draft shield MS-DS-21 for models with readability of 10 mg up to 100 mg.

12121014

Auxiliary displays



RS232C auxiliary display AD-RS-M7

12122381

Protective covers

Anti-theft devices



Anti-theft cable with lock

11600361

Software



EasyDirect Balance is an application software to collect, analyze, store and export balance measurement and device data on PC.

License EasyDirect Balance for 10 Instruments

30540473

License EasyDirect Balance for 3 Instruments

30539323

Various

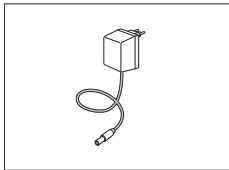

AC/DC universal adapter (EU, USA, AU, UK) 100–240 VAC, 50/60 Hz, 0.5 A, 12 VDC 1 A

11120270

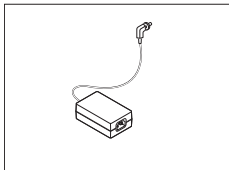

AC/DC adapter (without power cable)

11107909

- Input: 100 – 240 V AC, 50/60 Hz, 0.8 A
- Output: 12 V DC, 2.5 A

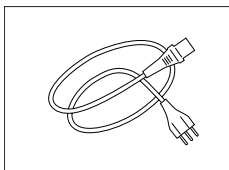

Country-specific 3-Pin power cable with grounding conductor.

Power cable AU

00088751

Power cable BR

30015268

Power cable CH

00087920

Power cable CN

30047293

Power cable DK

00087452

Power cable EU

00087925

Power cable GB

00089405

Power cable IL

00225297

Power cable IN

11600569

Power cable IT

00087457

Power cable JP

11107881

Power cable TH, PE

11107880

Power cable US

00088668

Power cable ZA

00089728

Adjustment weights



OIML / ASTM Weights (with calibration certificate)
see www.mt.com/weights

12.2 Spare parts

12.2.1 Balances with a readability of 0.1 mg with draft shield (236 mm)

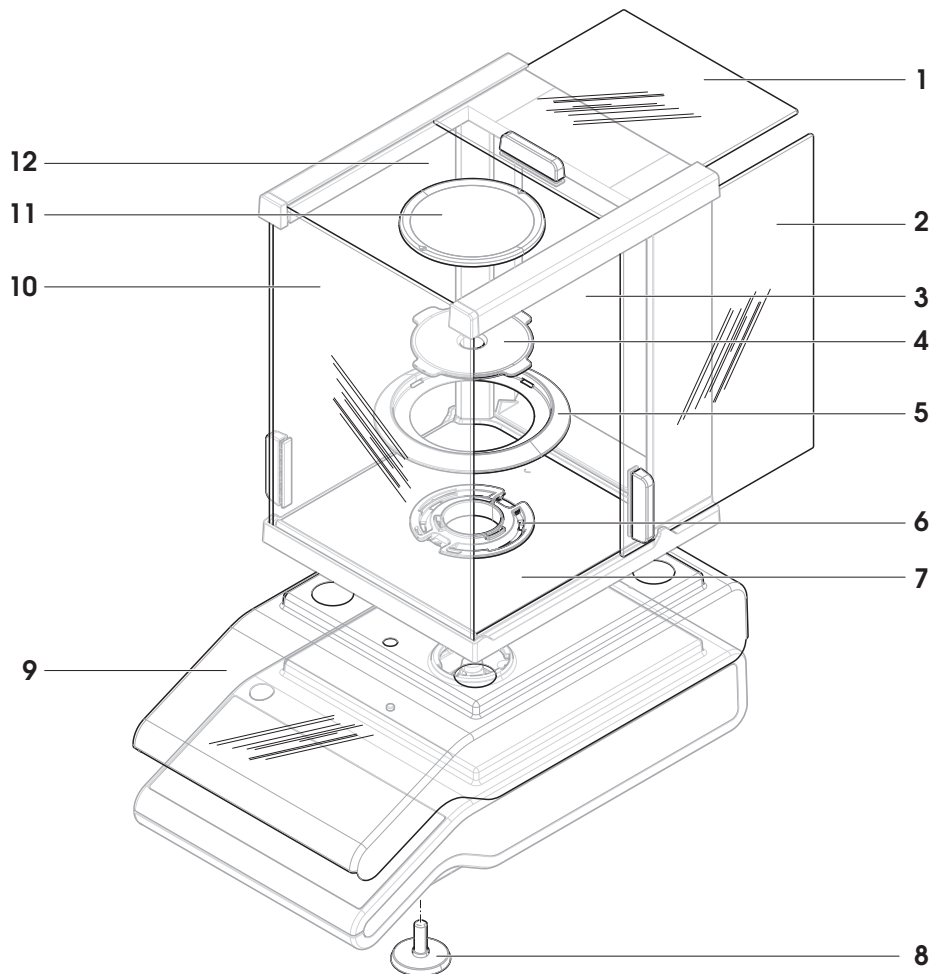

	Order no.	Designation	Remarks
1	12121884	Top glass with handle	–
2	12121882	Side glass door right high	Including: Handle
3	12122012	Rear glass high	–
4	11124249	Pan support ø 90 mm	–
5	12122008	Draft shield element	–
6	12122013	Draft shield lock	–
7	12122019	Bottom plate	–
8	30104835	Pair of leveling feet	–
9	30216667	Protective cover	–
10	12122011	Front glass high	–
11	12122010	Weighing pan ø 90 mm	Excluding: Pan support
12	12121880	Side glass door left high	Including: Handle

12.2.2 Balances with a readability of 1 mg with draft shield (168 mm)

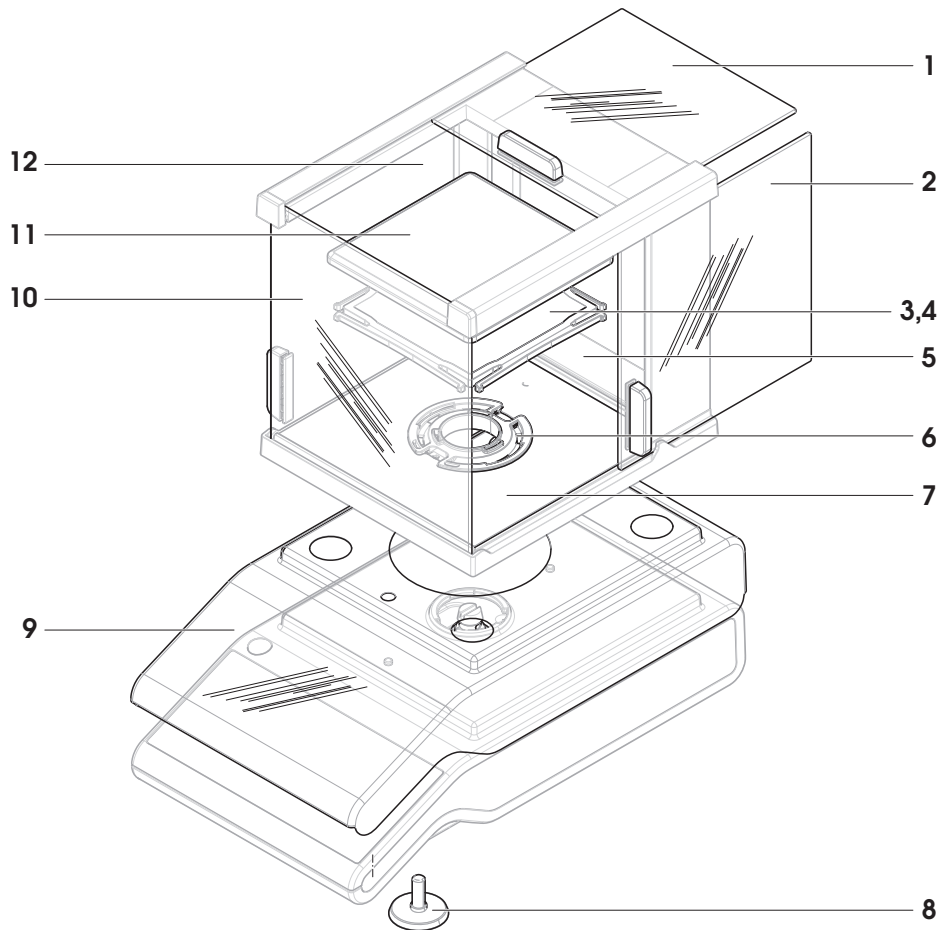

	Order no.	Designation	Remarks
1	12121884	Top glass with handle	–
2	12121883	Side glass door right	Including: Handle
3	12122017	Pan support 127×127 mm	for models up to 999 g capacity
4	12122016	Pan support 127×127 mm	for models from 1000 g capacity
5	12122015	Rear glass low	–
6	12122013	Draft shield lock	–
7	12122019	Bottom plate	–
8	30104835	Pair of leveling feet	–
9	30216667	Protective cover	–
10	12122014	Front glass low	–
11	12122009	Weighing pan 127×127 mm	–
12	12121881	Side glass door left low	Including: Handle

12.2.3 Balances with a readability of 10 mg

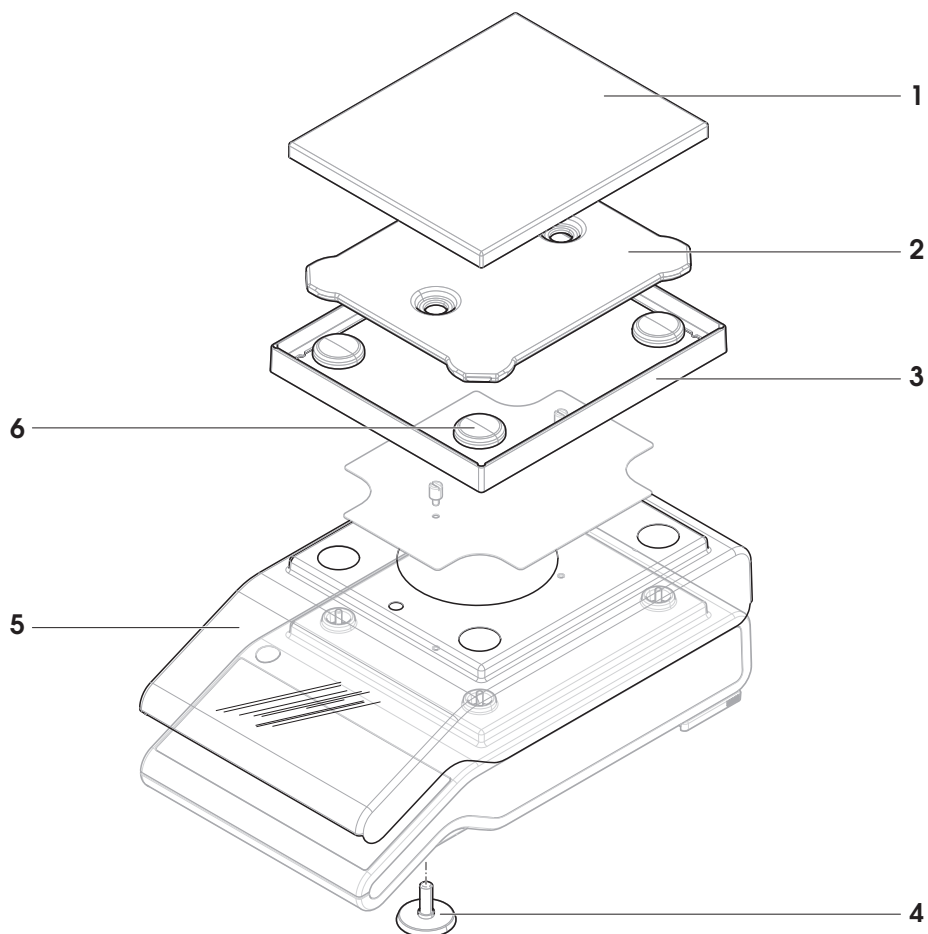

	Order no.	Designation	Remarks
1	11124247	Weighing pan 170×200 mm	–
2	12121064	Pan support 170×200 mm	–
3	12122018	Draft shield element 170×200 mm	–
4	30104835	Pair of leveling feet	–
5	30216667	Protective cover	–
6	11131029	Cap pan support	–

12.2.4 Balances with a readability of 100 mg

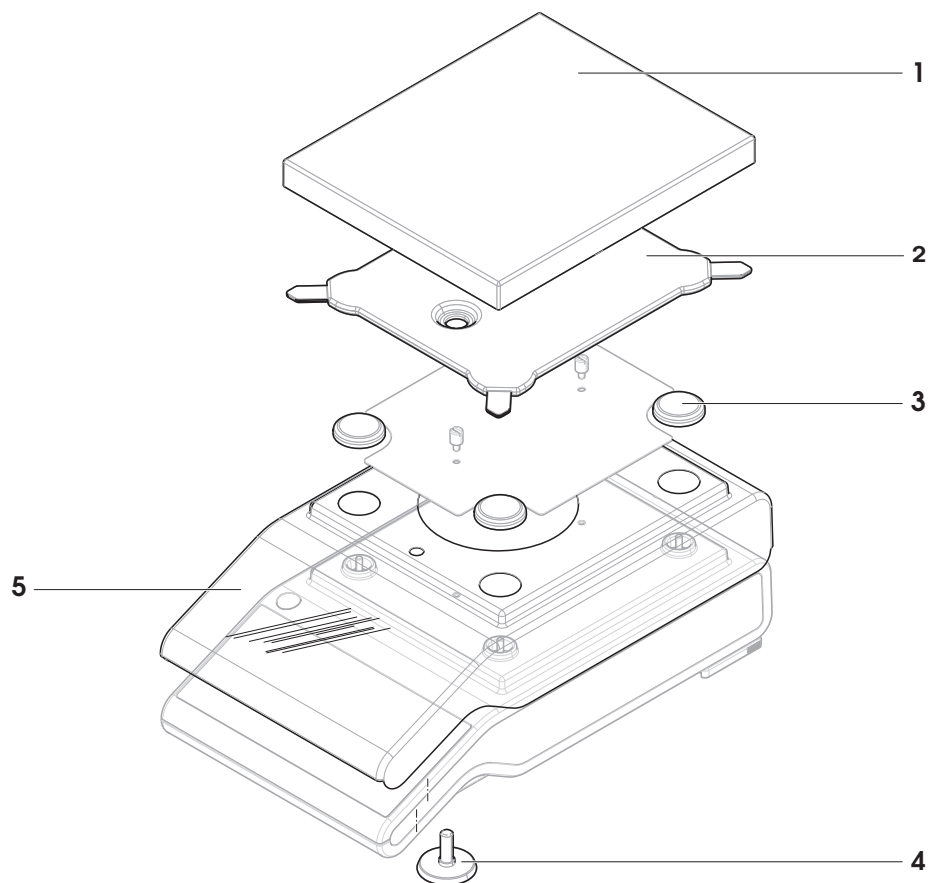

	Order no.	Designation	Remarks
1	11124248	Weighing pan 190×226 mm	—
2	12121066	Pan support 190×226 mm	—
3	11131029	Cap pan support	—
4	30104835	Pair of leveling feet	—
5	30216667	Protective cover	—

13 Disposal

In conformance with the European Directive 2012/19/EU on Waste Electrical and Electronic Equipment (WEEE) this device may not be disposed of in domestic waste. This also applies to countries outside the EU, per their specific requirements.



Please dispose of this product in accordance with local regulations at the collecting point specified for electrical and electronic equipment. If you have any questions, please contact the responsible authority or the distributor from which you purchased this device. Should this device be passed on to other parties, the content of this regulation must also be related.

14 Appendix

14.1 Compliance information

European Union

The instrument complies with the directives and standards listed on the EU Declaration of Conformity.

United States of America

This equipment has been tested and found to comply with the limits for a **Class A** digital device, pursuant to part 15 of the FCC Rules. These limits are designed to provide reasonable protection against harmful interference when the equipment is operated in a commercial environment. This equipment generates, uses, and can radiate radio frequency energy and, if not installed and used in accordance with the instruction manual, may cause harmful interference to radio communications. Operation of this equipment in a residential area is likely to cause harmful interference in which case the user will be required to correct the interference at his own expense.

This device complies with Part 15 of the FCC Rules. Operation is subject to the following two conditions:

1. This device may not cause harmful interference.
2. This device must accept any interference received, including interference that may cause undesired operation.

Changes or modifications not expressly approved by the party responsible for compliance could void the user's authority to operate the equipment.

The FCC Supplier Declaration of Conformity is available online.

► <http://www.mt.com/ComplianceSearch>

Index

A

AC/DC adapter	127
Access rights	48
Accessories	143
Action buttons	13
Activities	13
Back-weighing	78
Check weighing	66
Counting	62
Density	92
Differential weighing	81
Dynamic weighing	69
Factor weighing	94
Formula	72
Percent weighing	71
Totaling	75
Weighing	61
Applications	60
Adjusting	26
Adjustments	95
Adjustments and tests	95
Advanced options	46
Air bubble	24
Application home screen	13
Auto lock	
Auto lock function	48
Autoincrement	57
Autopublish	41

B

Backlight	46
Back-weighing	78
Balance history	54
Balance information	13
Barcode reader	41, 91, 110
Baudrate	42
Beep	32
Below-the-balance weighing	29
Bit/Parity	43
Bluetooth	44, 108, 142
Bluetooth devices	41

C

Changing the readability	28
Changing the time	23

Check weighing	66
Cleaning	116
Coach text field	13
Command host	40
Compliance information	6
convention	5
Conventions and symbols	5
Counting	62

D

Date	24
Defining reference piece number	63
Defining statistics	58
Defining the measuring time	69
Defining tolerance threshold	68
Density	92
Density kit	146
Devices and services	41
Differential weighing	81, 83
Initial weighings first	83
Sample by sample	87
Differential weighing results	91
Dimensions	136
Display results	59, 74, 77
Disposal	153
Dosing	34
Draft shield	21
Dynamic weighing	69

E

EasyDirect Balance	40
EasyDirectBalance	104
Entering characters and numbers	14
Environment	34
environmental condition	19
Environmental conditions	127
Ethernet	107, 141
Export report file	38

F

FACT	95
Factor weighing	94
Fill up	72
Fill up sample	72
Formula	72
FTP server	41

Function PC-Direct 101

G

General configuration and data 34
 Publishing 37
 System settings 46
 USB device 43
General settings 31
Groups 48

H

Handshake 43
History 54
Host 141

I

Identification dialog screen 56
Information and work bars 13
Information fields 13
Input prompt 57
install
 site 19
Installing the components 21
Interface
 MT-SICS 142
 USB device 141
Interface RS232C 140
Internal adjustment 96
ISO-Log 54

L

LAN 41, 44, 104, 107, 115, 141
Language 32
Level indicator 24
Leveling 24
Leveling assistant 25, 33
Leveling foot 9
Leveling the balance 24
location 19

M

Main activity configuration 13
Main navigation 13
Materials 127
Measuring time 69
Memory stick 112
MinWeigh 36
MT-SICS 142

MT-SICS commands 115

N

Navigation 15
Net 27
Network 44
Network devices 41

O

Operating temperature 23
Operation keys 9
Overview 12

P

Password 34
 User password 47
PC software 104
PC-Direct 40, 101
Percent weighing 71
Performing a dynamic weighing 70
Performing a simple weighing 27
Performing formula 72
Power supply 127
Print 13, 28, 38
Print report 38
Printer 41, 106, 107, 108
Protection and standards 127
Publishing 37

R

Reference piece number 63
Reset balance 46
RS232C interface 41, 42, 140

S

Safety information 7
 Signal words 7
 Warning symbols 7
Sample ID 110
Scope of delivery 20
Setting FACT 96
Settings/preferences 13
Short balance information 13
Signal words 7
Simple weighing 27
Sleep mode 46
Sound 32
Statistics 58

Statistics configuration	58	Weighing-in aid	13
Status icons	124	Wi-Fi	142
Status information field	13	Wireless dongle	44, 108
Status messages	124	WLAN	41, 44, 142
Switching off	28	Work title bar	13
Switching the weighing unit symbol	27 5	Workflow feedback beep	32
System settings	46	Z	
T		Zero setting	27
Taring	27		
Technical data	127		
Technical data dimensions	136		
Threshold	66		
Time	24		
Totaling	75		
Touch beep	32		
Transmit data	28		
transport			
long distance	29		
Transport over short distances	29		
Transporting the balance	29		
U			
USB	41		
USB cable	106		
USB device	43		
USB device interface	100, 141		
USB driver installing	100		
USB host	141		
USB Host interface	41		
USB keyboard	111		
User interface	12		
User management	47		
Users	50		
V			
Value bar	13		
W			
Warm-up time	23		
Warning symbols	7		
Web access	109		
Weighing	61		
Weighing information bar	13		
Weighing mode	34		
Weighing unit	13		
Weighing value field	13		

GWP®

Good Weighing Practice™

GWP® is the global weighing standard, ensuring consistent accuracy of weighing processes, applicable to all equipment from any manufacturer. It helps to:

- Choose the appropriate balance or scale
- Calibrate and operate your weighing equipment with security
- Comply with quality and compliance standards in laboratory and manufacturing

 www.mt.com/GWP

www.mt.com/balances

For more information

Mettler-Toledo GmbH

Im Langacher 44
8606 Greifensee, Switzerland
www.mt.com/contact

Subject to technical changes.
© Mettler-Toledo GmbH 01/2022
30235435M en



30235435